

High Power LED Par Light

USER MANUAL

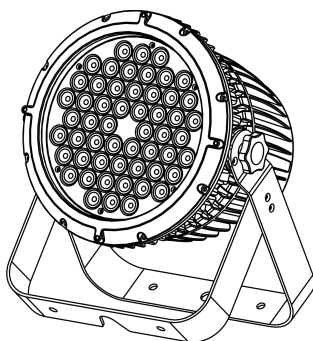

PS-3544

CATALOG



Please read the manual before installing and using this lighting

Keep it for future reference

1.	General	2
2.	Safety Warning	3
3.	Dimension	5
4.	Power connection	5
5.	Data connection	5
6.	Control panel	6
	➤ Button	6
	➤ Indicator	6
7.	Common operation	6
	➤ Manual dimmer	6
	➤ Creating static colors	7
	➤ Run built-in programs	8
	➤ Run programmable macro	9
	➤ Stand-alone mode	10
	➤ Master/slave mode	11
	➤ DMX mode	11
	➤ Setting DMX start address	12
	➤ Selecting 8/3 channels mode	12
	➤ Run if there is no signal in DMX mode	13
	➤ Reload manufacturer's Data	13
	➤ Display reverse	14
	➤ Display sleep function	14
	➤ ID addressing	15
8.	Menu	15
	➤ Main menu navigation	15
	➤ Detailed menu	17
9.	Channel function	20
	➤ STAGE 8-channel mode	21
	➤ HSV 3-Channel mode	24
10.	Photometrics	25
11.	Technical Specification	26

1. General

Thank you for purchasing our Products .This product is designed for indoor and outdoor use. It is suitable for disco, stage, building etc. as high power LED effect lighting. This product can be operated as a single unit or in multiple units for large applications. Direct input of DMX512 signal to unit to allow it is controlled by any DMX512 controller. Powerful internal programs and friendly and convenient operation interface allow customers to program freely to any different lighting project requirements for installation or shows.

This product complies with the following standards:

IEC60598-1:2014

IEC60598-2-17:1984+A2:1990

On receiving products, please carefully check that there has been no damage caused in transportation and that the following parts are enclosed:

Power Cable -----	1 PCS	Signal Output Cable -----	1 PCS
User Manual -----	1 PCS	Signal Input Cable -----	1 PCS

Features

- 4-digit display, with power and data indication .
- 256 degree brightness adjust, RGBW Mix could reach 16,000,000 Colors.
- 5 Built-in color temperature adjustments function , strobe function , auto running ,master/slave working mode .
- 8 DMX control channels (STAGE mode) or 3 DMX control channels (HSV mode)

- Thermal overload protection.
- High brightness and Long project distance.
- We have created the grayscale adjusting and regulation technique. It makes the dimmer become smoother.
- ID function.

2. Safety Warning

Every person involved with the installation, operation and maintenance of this device has to know:

- 1) This product must be installed by a qualified professional.
- 2) This product left the place of manufacture in perfect condition. In order to maintain this condition and for safe operation, the user must always follow the instructions and safety warnings described in this user manual.
- 3) Manufacturer will not with responsibility for those operations not according to this Instruction.

Operation attention

- Always make sure that you are connecting to the proper voltage, and that the line voltage you are connecting to is not higher than that stated on the decal or rear panel of the fixture.
- Always ground (earth) the fixture electrically.
- During long periods of non-use, disconnect the unit's main power.
- Do not attempt to operate this unit if the power cord has been frayed or broken.
- There are no user serviceable parts inside the unit. Do not open the

housing or attempt any repairs yourself.

- Maximum ambient temperature (T_a) is 40°C.
- The surface temperature of the light can reach to 65° C, cool down at least before you operate the light.
- The minimum distance between light-output and the illuminated surface must be more than 1 meters. Keep all combustible materials (for example fabric, wood, paper) at least 0.5 meters away from the fixture.
- Avoid looking directly into the light source (especially those who suffer from epileptic fits)
- Always mount this unit in safe and stable matter.
- When suspending the fixture above ground level, verify that the structure can hold at least 10 times the weight of all installed devices.
- Verify that all external covers and rigging hardware are securely fastened and use an approved means of secondary attachment such as a safety cable.
- Block access below the work area whenever installing or removing the fixture.
- Avoiding hit the Light when you are move or install the light.
- If the exterior cord of the fixture is damaged, it must be replaced by manufactory, agent or a qualified technician.

3. Dimension

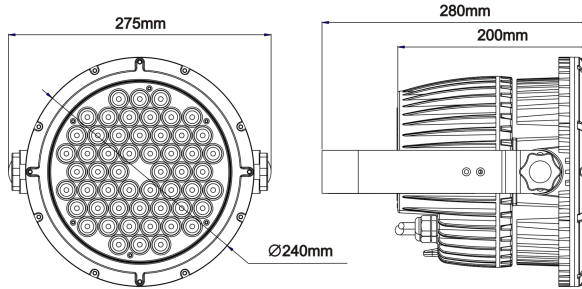

4. Power connection

Connect the enclosed power transform cable to the POWER IN of the 1st lighting, and connect the POWER IN of the 2nd to POWER OUT of the 1st lighting, and so on. Do not connect more than 10 PCS in the Same Circuit series.

5. Data connection

Connect the DMX-output of the controller to DMX IN of the lighting by the enclosed signal cable, if you want to connect more lightings, connect DMX OUT of the first lighting to the DMX IN of the next lighting, and so on. Solder a 120Ω resistor between Signal (-) and Signal (+) into a 3-pin XLR-plug and plug it in the DMX-output of the last lighting can prevents electrical noise from disturbing and corrupting the DMX control signals.

6. Control panel

➤ **Button**

- SET:** Call the main menu, or escape the current menu (i.e. return to the upper menu and give up the selected item or parameter).
- UP:** Browse the menu item forward or increase the parameter.
- DOWN:** Browse the menu item backward or decrease the parameter.
- ENTER:** Confirm the selected item or parameter(i.e. enter the next menu, or escape the current menu and save the selected item or parameter)

➤ **Indicator**

There are 4 dots at the bottom of the digital tube, from left to right as:

1. DMX signal LED indicator
2. Memory writing indicator, (Press ENTER after amending the DATA, This Dot will be light up, it means the Data is saving)
3. Power indicator
4. Keyboard available indicator

7. Common operation

➤ **Manual dimmer**

Power on, the lighting shows *A001*

Press UP or DOWN buttons to browse to *COL*(manual dimmer),

Press ENTER , shows *ADJ*,

Press UP or DOWN buttons to browse to the flowing menu

SWCH light switch

RED red dimmer

GRN green dimmer

BLU blue dimmer

PWHI pure white dimmer

STB strobe adjustment

If you want to adjust one of above items, press ENTER to enter and adjust by pressing UP and DOWN buttons, then press ENTER to confirm

➤ ***Creating static colors***

The static colors not only can be created in Manual menu but also in the ready color menu. After Power on, press UP or DOWN buttons to browse to below menu, the lighting will create static colors:

RED (red)

GRN (green))

BLU (blue)

YEL (yellow)

CYN (cyan)

PUR (purple)

PWHI (pure white)

AWHI (white)

3200 (3200K white)

5600 (5600K white)

6500 (6500K white)

8500 (8500K white)

1000 (10000K white)

➤ ***Run built-in programs***

Power on, press UP or DOWN buttons to browse to the below menu, the lighting will run the built-in programs

CHCL (color change program)

STOB (strobe program)

FADE (fade program)

While running built-in program, press ENTER to adjust the speed .

➤ ***Run programmable macro***

Power on, press UP or DOWN buttons to browse to *MACR*, the lighting will run macro, press ENTER to enter can browse to the below menus:

1. *SPED*(adjust the program speed)

2. *PRNU*(program steps number)

Macro call the built-in programs circularly, each step is one of built-in program. This menu is used for setting the steps number. If the number is set to 3, so the lighting runs 3 built-in programs circularly ,when use UP and DOWN buttons to browse the menu , you just can see 3 step:*STO1*, *STO2*, *STO3* . The number could be set to 62 mostly.

3. *STO1*(choice menu of the 1st step)

Press ENTER-button, then use UP and DOWN buttons to browse to your desired built-in program including *CHCL* , *STOB* , and *FADE* , press

ENTER-button to assign one of the built-in programs to Step1 or press SET

button to cancel and return .

4. **STO2**(choice menu of the 2st step)

Press ENTER-button, then use UP and DOWN buttons to browse to your desired built-in program including *CHCL* , *STOB* , and *FADE* , press ENTER-button to assign one of the built-in programs to Step2 or press SET button to cancel and return

... ..

e.g.:

Set steps number to 3

STO1 choose the *FADE* program

STO2 choose the *CHCL* program

STO3 choose the *STOB* program

The program runs as right figure.

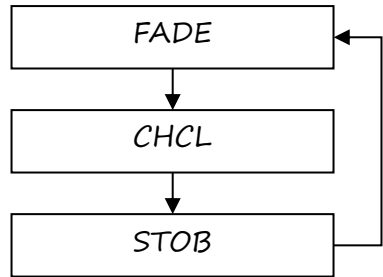

➤ **Stand-alone mode**

In Stand-alone mode, the lighting out of control of any exterior signal, run solely. Setting method is:

Press SET-button until shows **SET** (set menu)

Press ENTER-button

Press UP or DOWN-button to browse to **MAAL**

Press ENTER-button

Press UP or DOWN-button to browse to **ALON** (alone)

Press ENTER - button to confirm.

➤ **Master/slave mode**

Set one lighting to master-device , and others to slave-device , so all lightings run synchronously follow the master-device .

1. Setting Master-device

Press SET-button until shows **SET** (set menu)

Press ENTER-button

Press UP or DOWN-button to browse to **MAAL**

Press ENTER-button

Press UP or DOWN-button to browse to **MAST** (master)

Press ENTER - button to confirm.

2. Slave-device setting

Press the lighting to DMX mode position.

➤ **DMX mode**

In DMX mode, the lighting can controlled by controller. When the display shows **A001** or the other actual stored addresses. The lighting is in DMX mode.

➤ **Setting DMX start address**

In DMX mode, a fixture requiring one or more channels for control begins to read the data on the channel indicated by the start address. For example, a fixture that uses 3 DMX channels and was addressed to start on DMX channel 1, would read data from channels: 1, 2, 3. Choose start addresses so that the channels used do not overlap, and note the start address selected for future reference. Note that assign the same address to the different lightings, they will receive the same signal.

Setting DMX address method:

When the lighting is in DMX mode, and showing the stored address,,

Press ENTER, shows **DMX** (DMX menu)

Press ENTER

Press UP or DOWN to browse to **ADDR**

Press ENTER

Press UP or DOWN to set DMX address

Press ENTER to confirm

➤ **Selecting 8/3 channels mode**

When the lighting is in DMX mode, and showing the stored address,,

Press ENTER, shows **DMX** (DMX menu)

Press ENTER

Press UP or DOWN to browse to **CHS**

Press ENTER

Press UP or DOWN to browse to *HSV* (3 channels) \ *STAG* (8 channels)

Press ENTER to confirm

➤ ***Run if there is no signal in DMX mode***

When the lighting is in DMX mode, and shows the stored DMX address,

Press ENTER, shows *DMX* (DMX menu)

Press ENTER

Press UP or DOWN to browse to *AUSO*

Press ENTER

Press UP or DOWN to browse to *STOP* (stop) / *AUTO* (auto) / *HOLD*

(hold)

Press ENTER to confirm

➤ ***Reload manufacturer's Data***

Press SET-button until displays *SET* (Set menu)

Press ENTER

Press UP or DOWN to browse to *LOAD*

Press ENTER

Press UP or DOWN to browse to *ON* (reload)/*OFF* (do not reload)

Press ENTER to confirm.

➤ **Display reverse**

Enable this function, the display rotated by 180°, either the buttons.

Press SET-button until shows **SET** (set menu)

Press ENTER-button

Press UP or DOWN-button to browse to **RDIS**

Press ENTER-button

Press UP or DOWN-button to browse to **ON** (reverse)/**OFF** (do not reverse)

Press ENTER - button to confirm.

➤ **Display sleep function**

By default the display is set to go into sleep mode 1 minute after the last key press. To reactivate the display, press any key. To modify or disable this setting through the menu. The setting method is

Press SET-button until display **SET** (set menu)

Press ENTER-button

Press UP or DOWN-button to browse to **CLDI**

Press ENTER-button

Press UP or DOWN-button to browse to *ON*(able)/*OFF* (disable)

Press ENTER-button

If *ON* is selected before hand , after press ENTER-button , the display shows *T-01* (1minute), press UP or DOWN-button can adjust the shutoff time .

➤ ***ID addressing***

ID code is used to extend DMX. Any DMX address in the range from 001 to 512 may be used , so a limited fixtures are controlled by DMX controller respectively in a series. However, the ID code function allows each DMX address may carry up to 66 separate ID addresses, so 66 fixtures could be respectively controlled with the same DMX address. For example : if the controller can control 63 fixtures in series , and the ID code function extend the quantity to $63 \times 66 = 4158$

Enter *SET* menu and find *ID* menu could set the ID code. ID addresses are accessible from CH4 on the DMX512 controller. If you don't want ID code function, CH4 must be inactive (CH4=0).

8. Menu

➤ ***Main menu navigation***

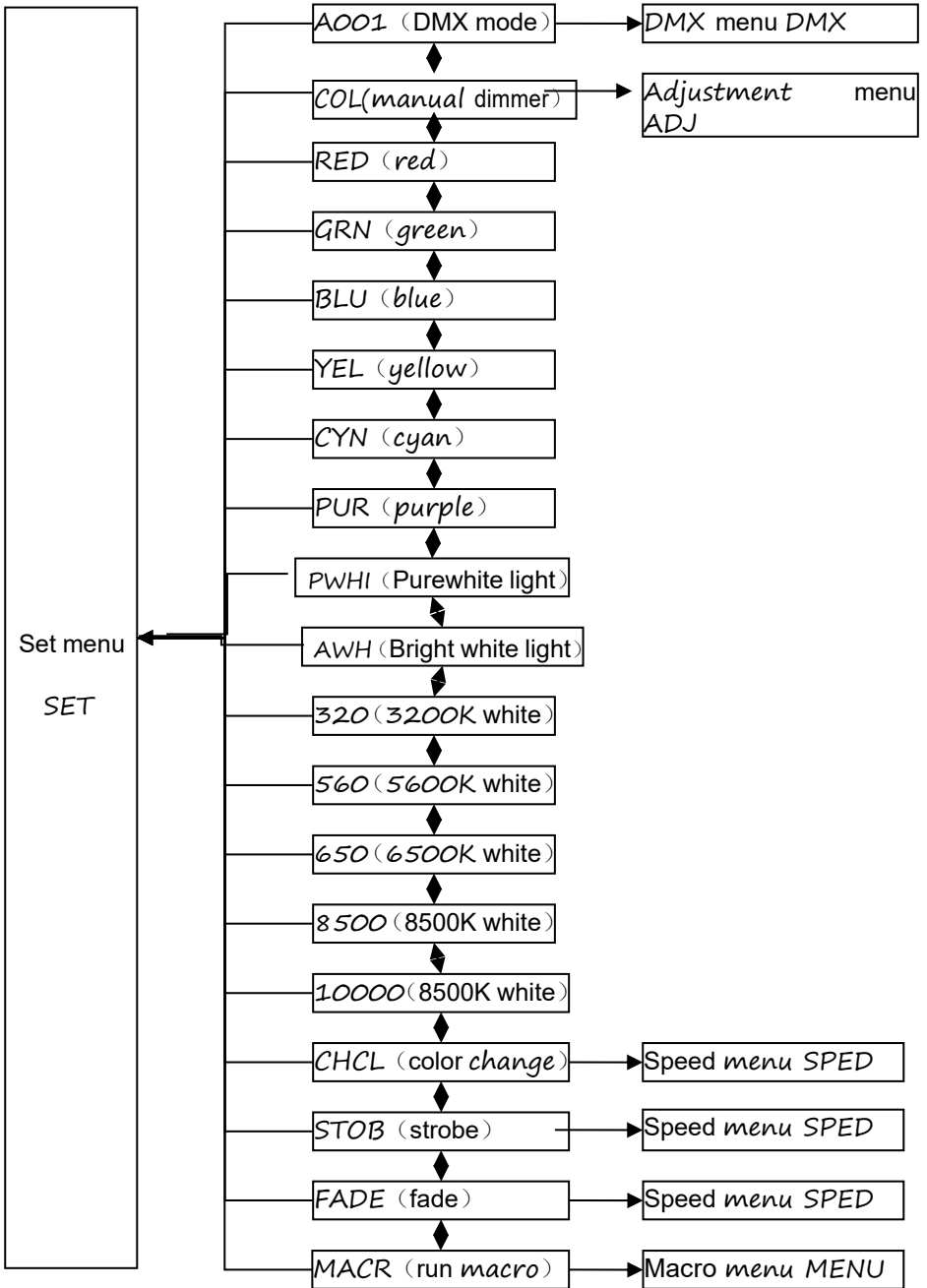

➤ **Detailed menu**

Main menu	Submenu	Submenu	Submenu
SET Set menu	ID ID code	0~66	
	LOAD Reload manufacturer's Data	ON yes	
		OFF no	
	MAAL Master/alone	MAST master mode	
		ALON alone mode	
	FLAS flash code	0~255	
	TCSW TC Switch , over temperature reduce output	TMSK	YES yes
		TC Switch	NO no
		TEMP pass-word protection common user prohibited	CAPT temperature capture
			TSET temperature setting
VER Soft Version	V-1.X		
RDIS	ON yes		

	Display-reverse	<i>OFF</i> off	
	<i>CLDI</i>	<i>ON</i> yes	<i>T-01</i>
	Display sleeping function	<i>OFF</i> off	One minute

DMX DMX menu	<i>A001</i> Set DMX address	<i>A001~ Axxx</i>	
	<i>CHS</i> Channel mode selection	<i>HSV</i> HSV mode (3 channels)	
		<i>STAG</i> STAG mode (8 channels)	
	<i>AUSO</i> Run if no DMX signal	<i>STOP</i> stop	
		<i>HOLD</i> hold	
		<i>AUTO</i> auto	
<i>DISP</i> content Displayed in DMX mode	<i>ADDR</i> DMX address, default setting		

		VALU Channel value	<i>CH00</i> the Changing channel
			<i>CH01</i> The 1st channel
			<i>CH02</i> The 2nd channel
		

ADJ Adjustment menu	SWCH light switch	<i>ON</i> on	
		<i>OFF</i> off	
	<i>RED</i> red dimmer	0~255	
	<i>GRN</i> green dimmer	0~255	
	<i>BLU</i> blue dimmer	0~255	
	<i>WHI</i> white dimmer	0~255	
	<i>STB</i> strobe speed	0~255	
SPED Speed menu	0~50		
MENU Macro	SPED speed	0~50	
	PRNU program number	0~62	

menu	<i>STO1</i> (choice menu of the 1st step)	<i>CHCL</i> Color change	
		<i>STOB</i> Strobe	
		<i>FADE</i> Fade	
	<i>STO2</i> (choice menu of the 2nd step)	<i>CHCL</i> Color change	
		<i>STOB</i> Strobe	
		<i>FADE</i> Fade	
		

9. Channel function

The lighting has two channel modes, STAGE 8 channels mode and HSV 3 channels mode . The channel modes could be selected by DMX menu.

(DMX\CHS\... see page 11)

➤ **STAGE 8-channel mode**

Channel 1- general dimmer

Value	Function
000-255	Dimmer(dark to bright)

Channel 2- Strobe

Not running built-in programs		While running built-in programs	
Value	Function	Value	Function
000-009	No function	000-004	Natural speed
010-149	Strobe(slow to fast)	005-255	Slow to fast
150-199	Slow in fast out		
200-249	Fast in slow out		
250-255	Always bright		

Channel 3- Especial function

Value	Function
000-049	Color controlled by RGBW dimmer channels (CH5~CH8) ,
050-059	Red
060-069	Green
070-079	Blue
080-089	Yellow
090-099	Cyan
100-109	Purple

110-119	Pure White
120-129	All White
130-139	3200K color temperature
140-149	5600K color temperature
150-159	6500K color temperature
160-169	8500K color temperature
170-179	10000K color temperature
180-189	Change Color program
190-199	Strobe program
200-229	Fade program
230-255	Macro program

Channel 4- ID function

Value	ID	Value	ID	Value	ID
0~9	ID1~66	212	ID23	235	ID46
10~19	ID1	213	ID24	236	ID47
20~29	ID2	214	ID25	237	ID48
30~39	ID3	215	ID26	238	ID49
40~49	ID4	216	ID27	239	ID50
50~59	ID5	217	ID28	240	ID51
60~69	ID6	218	ID29	241	ID52
70~79	ID7	219	ID30	242	ID53
80~89	ID8	220	ID31	243	ID54
90~99	ID9	221	ID32	244	ID55
100~109	ID10	222	ID33	245	ID56
110~119	ID11	223	ID34	246	ID57
120~129	ID12	224	ID35	247	ID58
130~139	ID13	225	ID36	248	ID59

140~149	ID14	226	ID37	249	ID60
150~159	ID15	227	ID38	250	ID61
160~169	ID16	228	ID39	251	ID62
170~179	ID17	229	ID40	252	ID63
180~189	ID18	230	ID41	253	ID64
190~199	ID19	231	ID42	254	ID65
200~209	ID20	232	ID43	255	ID66
210	ID21	233	ID44		
211	ID22	234	ID45		

Channel 5- Red dimmer

Value	Function
000-255	Red dimmer 0~100%

Channel 6- Green dimmer

Value	Function
000-255	Green dimmer 0~100%

Channel 7- Blue dimmer

Value	Function
000-255	Blue dimmer 0~100%

Channel 8- White dimmer

Value	Function
000-255	White dimmer 0~100%

➤ **HSV 3-Channel mode**

Channel 1- Hue

Value	Function
000-255	red→ yellow→ green→ cyan→ blue→ purple →red

Channel 2- Saturation

Value	Function
000-255	Saturation increase

Channel 3- Value

Value	Function
000-255	Color change from dark to bright

10.Photo metrics

WHITE

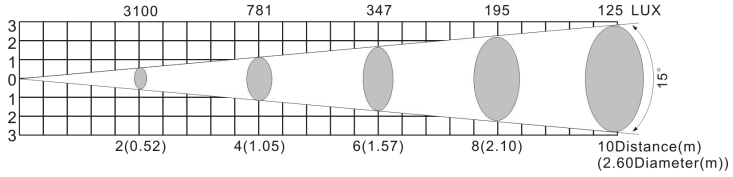

RED

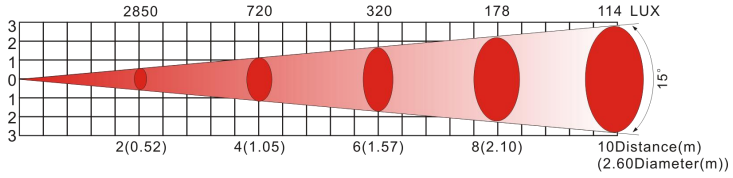

GREEN

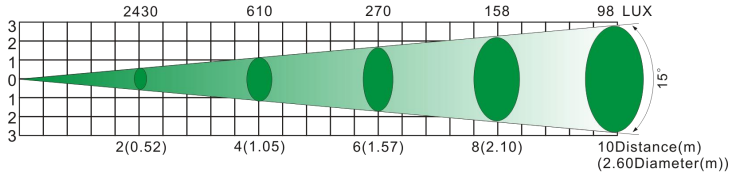

BLUE

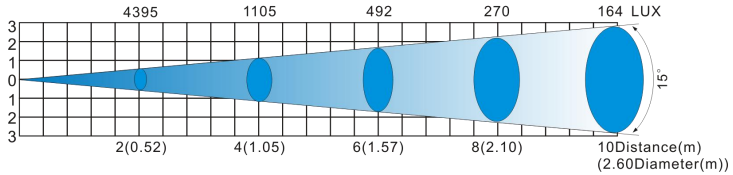

RGB

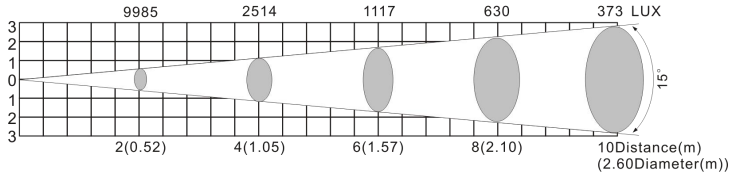

RGBW

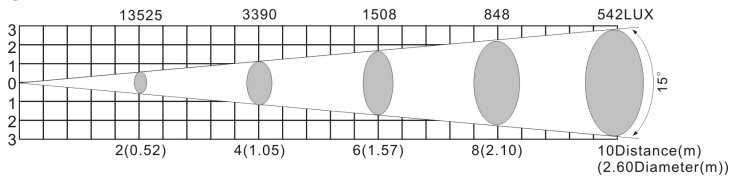

11. Technical Specification

Power supply	AC 100~240V, 50/60Hz
Power consumption	165W
Light source	54×3W LED (12R , 12G , 12B , 18W)
LED rated life	About 50,000 hours
Beam angle	□8°, □15°, ■25°, □45°, □60°
Effects	Color changing , Can create excellent color mixing with high even and uniform distribution of brightness and light output Variable electronic strobe 0~25F.P.S Variable electronic dimmer 0~100% Electronic strobe with pulse effects
DMX channels	3 or 8 channels (depend on HSV or STAGE mode selected through control panel)
Protocols	DMX-512
Control modes	DMX mode , Master/Slave mode
Housing	Aluminum
Protection rating	IP67
Thermostat	Built-in thermostat for overheating protection
Fixture dimensions	275×240×200mm
Net weight	7.5kg

NOTE: Due to improvement, the product specifications and this manual are subject to change without prior notice.