

# Wilgex®

Professional LED Light Manufacturer  
Since 2008

[www.wilgex-led.com](http://www.wilgex-led.com)

(86) 769-28820681

[info@wilgex-led.com](mailto:info@wilgex-led.com)

## IP20 LED LIGHT STRIP

### 120 LEDS WITH 20 ICs

**LIGHT LED STRIP**

**DYNAMIC PIXEL  
RGB COLOR  
24V**



### Structural Drawing & Bending Direction

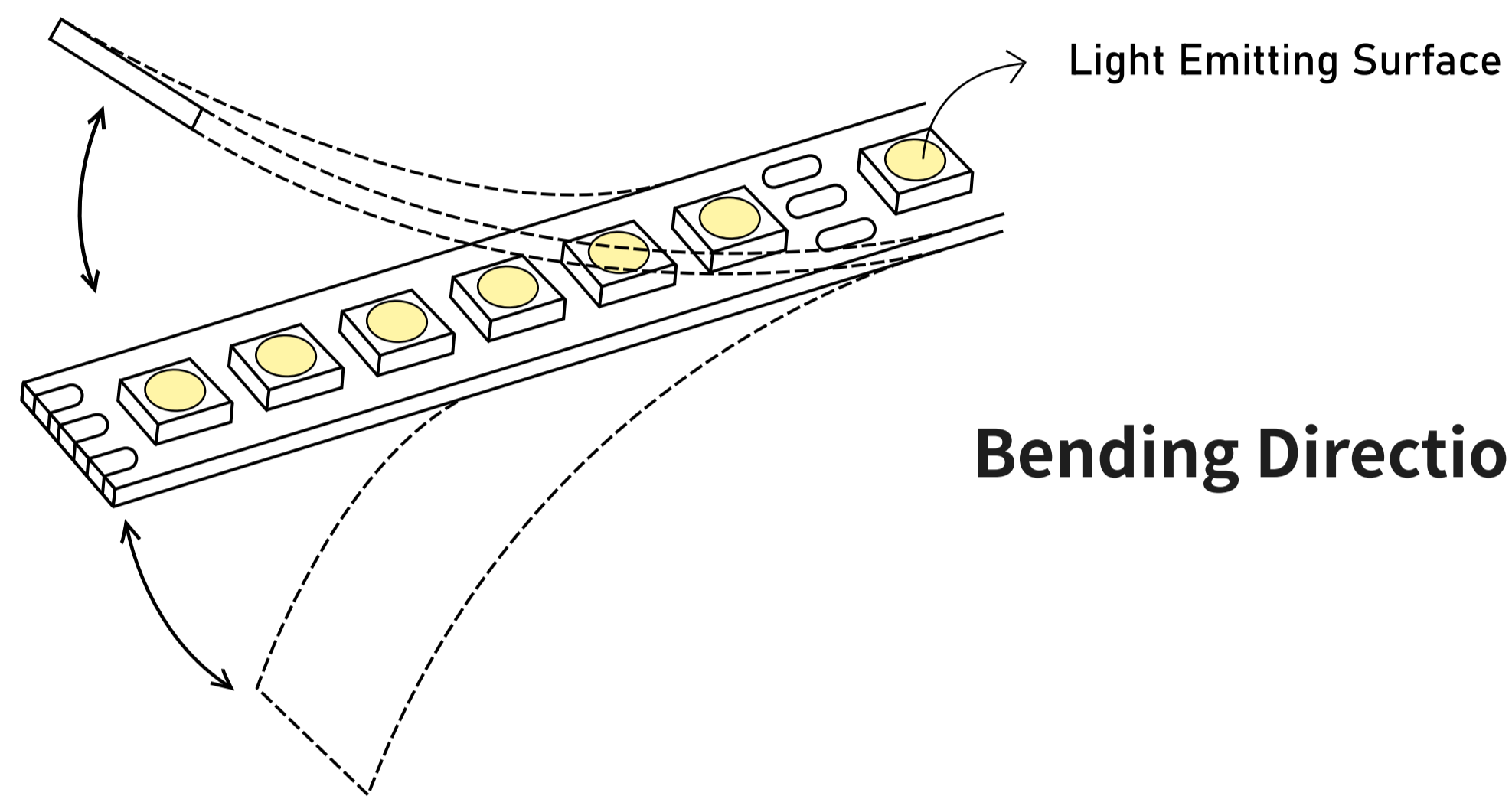
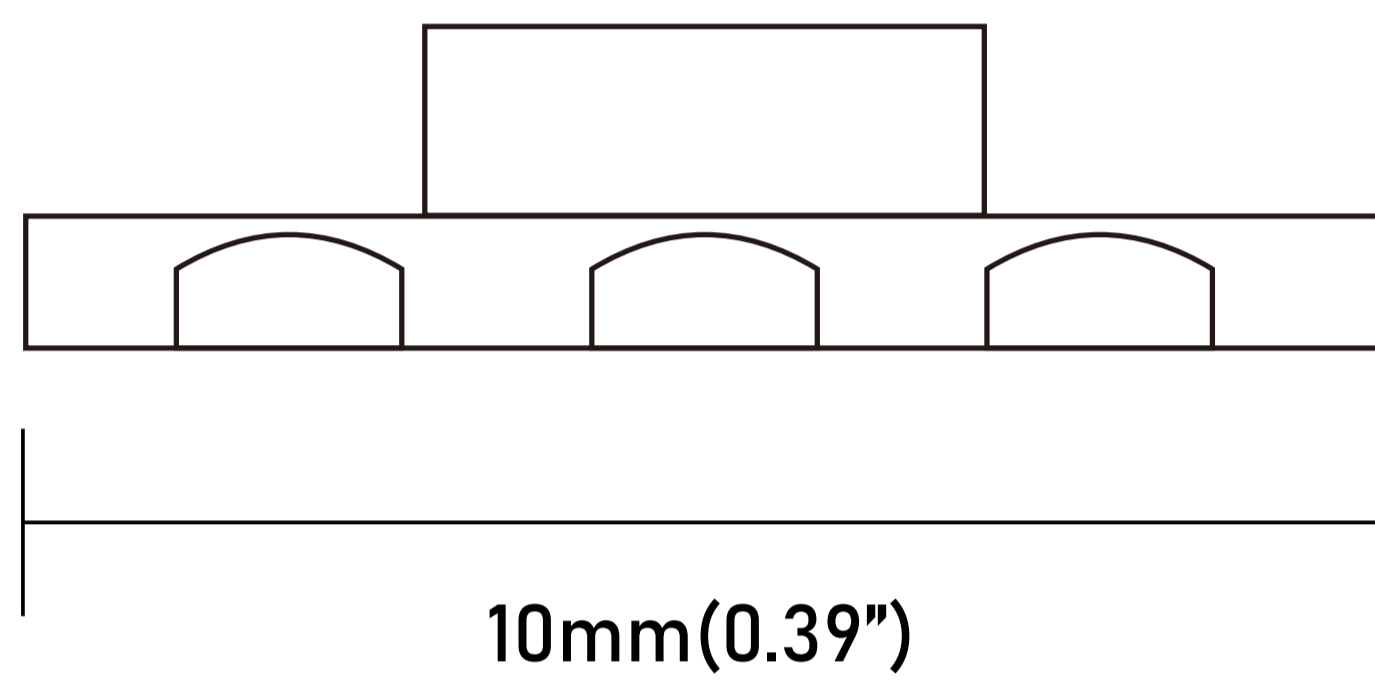

### Certifications



### Technical Data

SPI-RGB

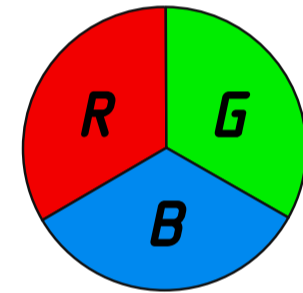

<b>Color Temp</b>	Red: 624.9nm Green: 525.6nm Blue: 469.4nm White: 6500K(Color mixing)	<b>Watts/m(24V)</b>	Red: 8.44 W Green: 9.01 W Blue: 9.02 W White: 21.91 W(Color mixing)
<b>Lumen/m (24V)</b>	Red: 178.62 lm Green: 518.00 lm Blue: 96.17 lm White: 707.84 lm(Color mixing)	<b>Unit Cut(24V)</b>	5cm
<b>LED Quantity(m)</b>	120 LEDs + 20 ICs IC code: SK6812 (compatible with all ICs and controllers in the WS2811, 1804, and 1809 series)	<b>Max Loading(24V)</b>	5m

### Optical Parameter Chart for Integrating Sphere Testing

**Chroma Parameters**  
Chro.Coor.: x=0.2158 y=0.2475 u=0.1559 v=0.2681 duv=0.0244  
CCT: Tc=50000K Dominant Wave.: 482.6nm Purity: 47.2%  
Flux Ratio: R=16.3%,G=70.8%,B=12.9% Peak Wave.: 465.7nm Half Width: 21.8nm

**Rendering Index: Ra= 60.7**  
R1 =63.5 R2 =60.5 R3 =64.5 R4 =72.9 R5 =81.4 R6 =61.0 R7 =53.9  
R8 =28.5 R9 =-141.8R10=8.8 R11=80.8 R12=60.6 R13=51.3 R14=78.2  
R15=38.5

**Photo Parameters**  
Flux: 707.84lm Effi.: 32.3lm/W Radiant: 3522.0mW Iv: 0.0mcd

**Ele. Parameters**  
Voltage:U=24.000V Current:I=0.9120A  
Power:P=21.91W Power Factor:PF=1.000

### Reliability test

TEST CATEGORY	TEST ITEMS	STANDARD/VALUE
Optical Test	Spectrum Analysis	IES LM 79(CCT, lumen, CRI, SDCM, XY, wavelength)
	Photometric Distribution	IES LM 79(lumen intensity distribution & Lux diagram)
	Lumen Maintenance & Lifetime	IES LM84 & IES TM 28
Temperature Test	Nomal Temperature Test -25°C	UL 1598 & UL2388 & IEC60598-1 & IEC60598-2-21
	Abnormal Operation Test -70°C	UL 1598 & UL2388 & IEC60598-1 & IEC60598-2-21
Physics Test	Bending Test	Manufacturer-defined, 1000 cycles
	Swing Test	UL2388, >750 cycles
	Tensile Test	Manufacturer-defined, >the weight of light in max. running length by double ends feed
	Twist Test	Manufacturer-defined, 200 cycles
	IK08	IEC62262
Weathering Test	Ball Impact	UL 1598 & UL2388 & IEC60598-1 & IEC60598-2-21
	Swimming Pool Water Immersion Test	GB9667, PH6.8-7.6, free chlorine 0.3-0.6mg/L
	Sea Water Immersion Test	IEC 60598-1, Salinity 4%
	Salt Spray Test	IEC68-2-11
Environment Test	Outdoor Exposure	Manufacturer-defined
	Flame Resistant Test	UL94
	UV Exposure Test	ASTMG154, UVA@340nm
	IPX5 IPX6 IPX7 IPX8	IEC60529
	Temperature Shock Test	Manufacturer-defined, -40°C-60°C(typical temperature range)
	Constant Temperature Test	Manufacturer-defined, 70°C(typical temperature range)

Wilgex specializes in engineering LED flexible neon lights and offers both standard and customized services. If you have specific requirements, please contact our sales department.

**Four-star quality assurance**

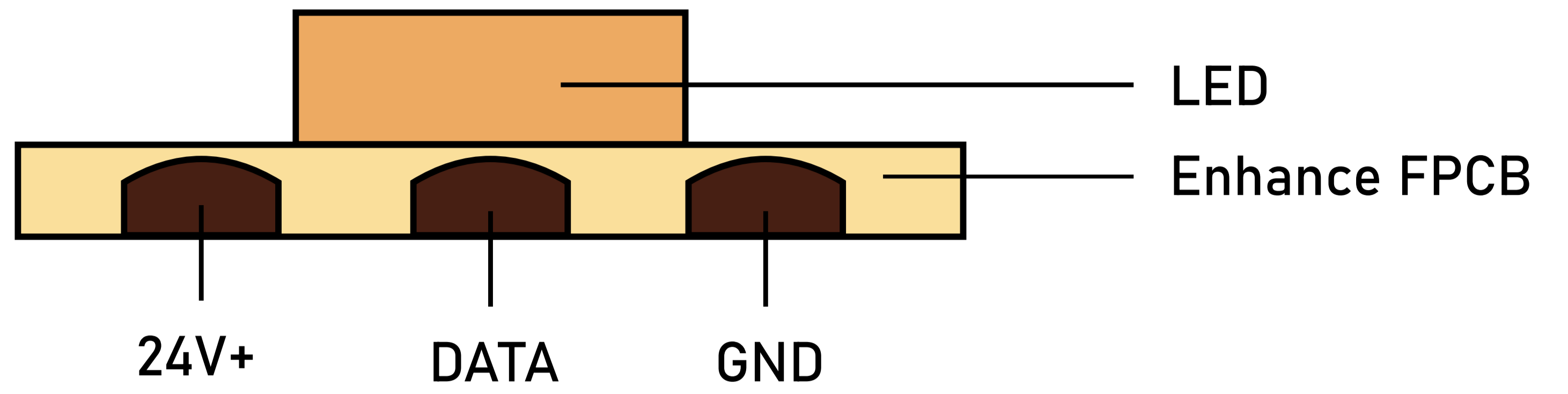

**Unique Design**

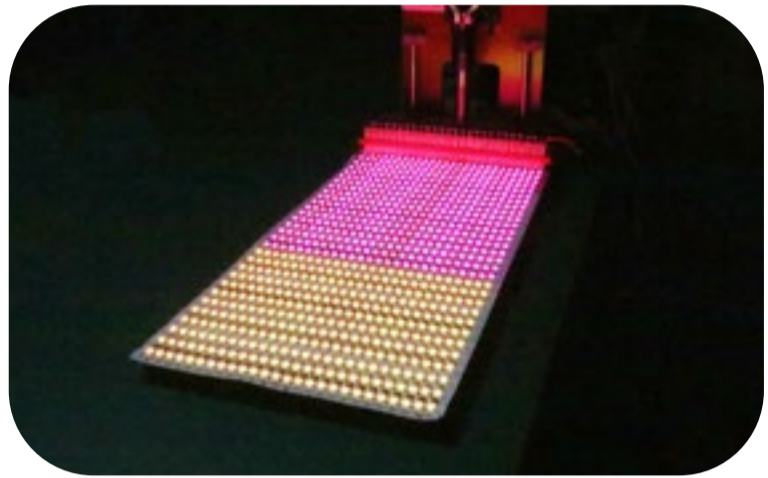

★ Enhance thickness FPC design principle

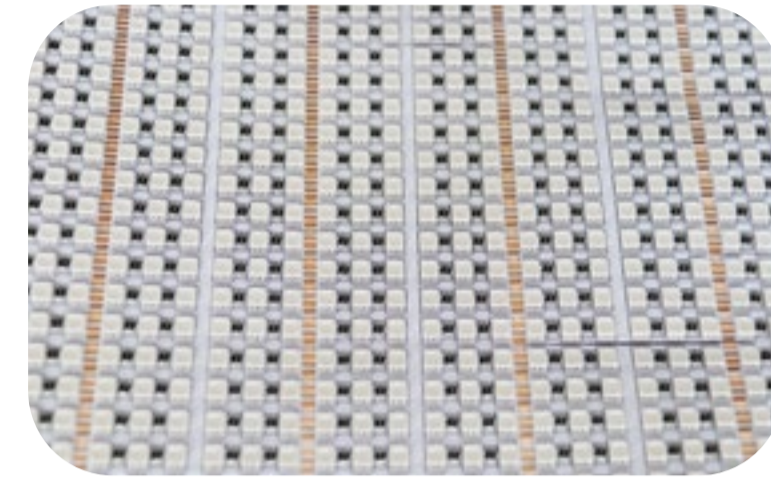

★ ★ LED anti-death design

**Wide Color Options**

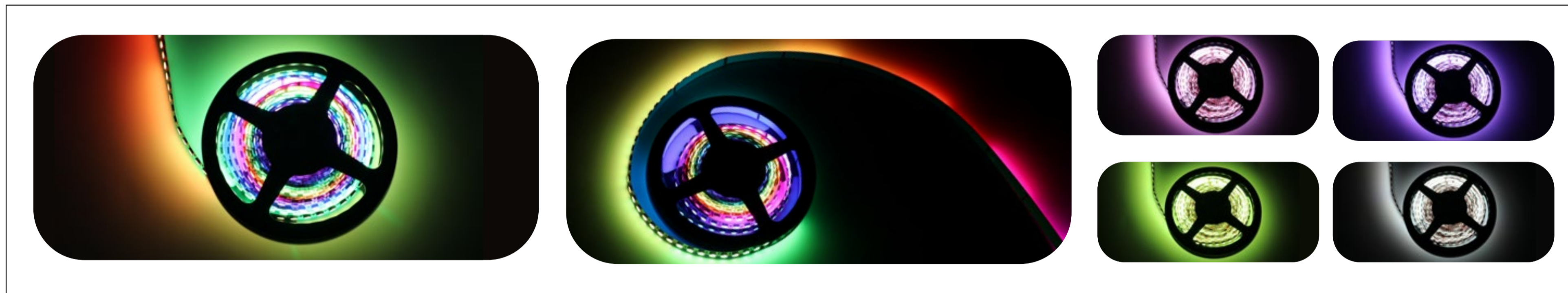

Dynamic Pixel RGB

**Recommended Usage Scenarios :**

1. Indoor and outdoor architectural lighting decoration
2. Landscape lighting
3. Advertising signage lighting
4. Stage and theater lighting
5. Car and motorcycle lighting
6. Holiday and event lighting decoration
7. Cove lighting
8. Edge-lit lighting
9. Retail and display lighting
10. Restaurant and bar lighting

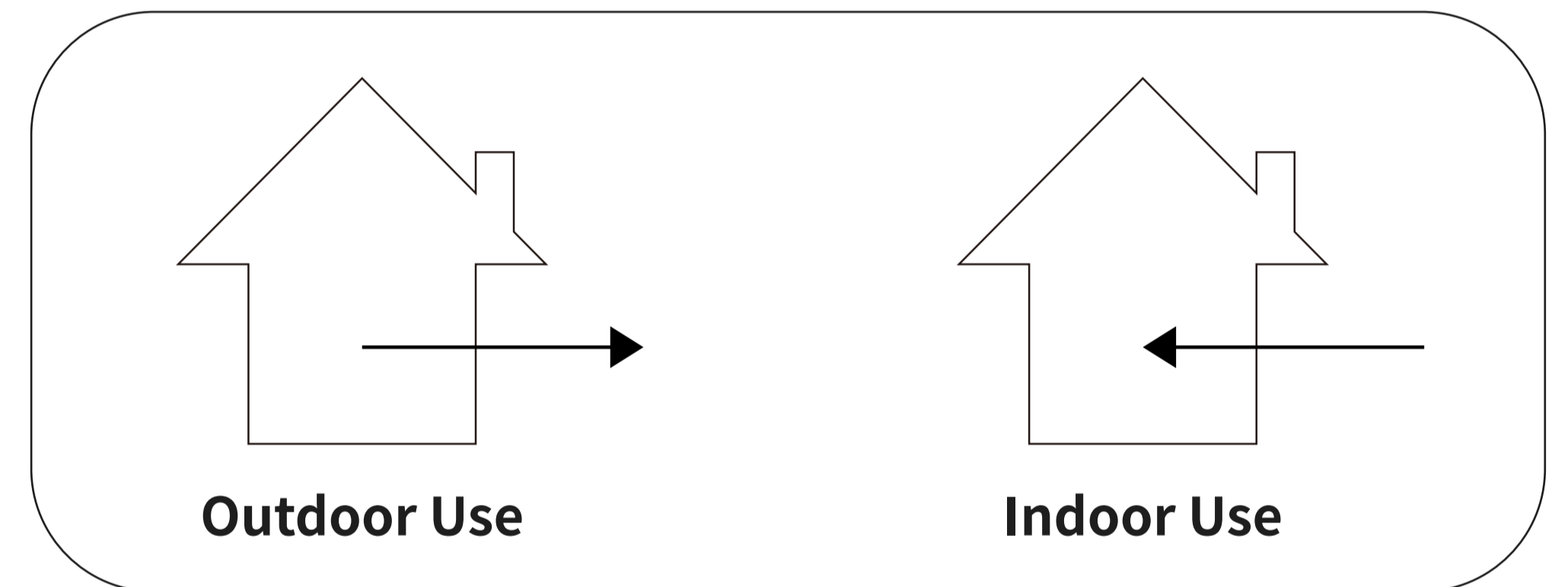

Please note that these are only recommended usage scenarios and it is important to consult the product specifications and guidelines before using flexible LED neon light strips in any application.



**Package**

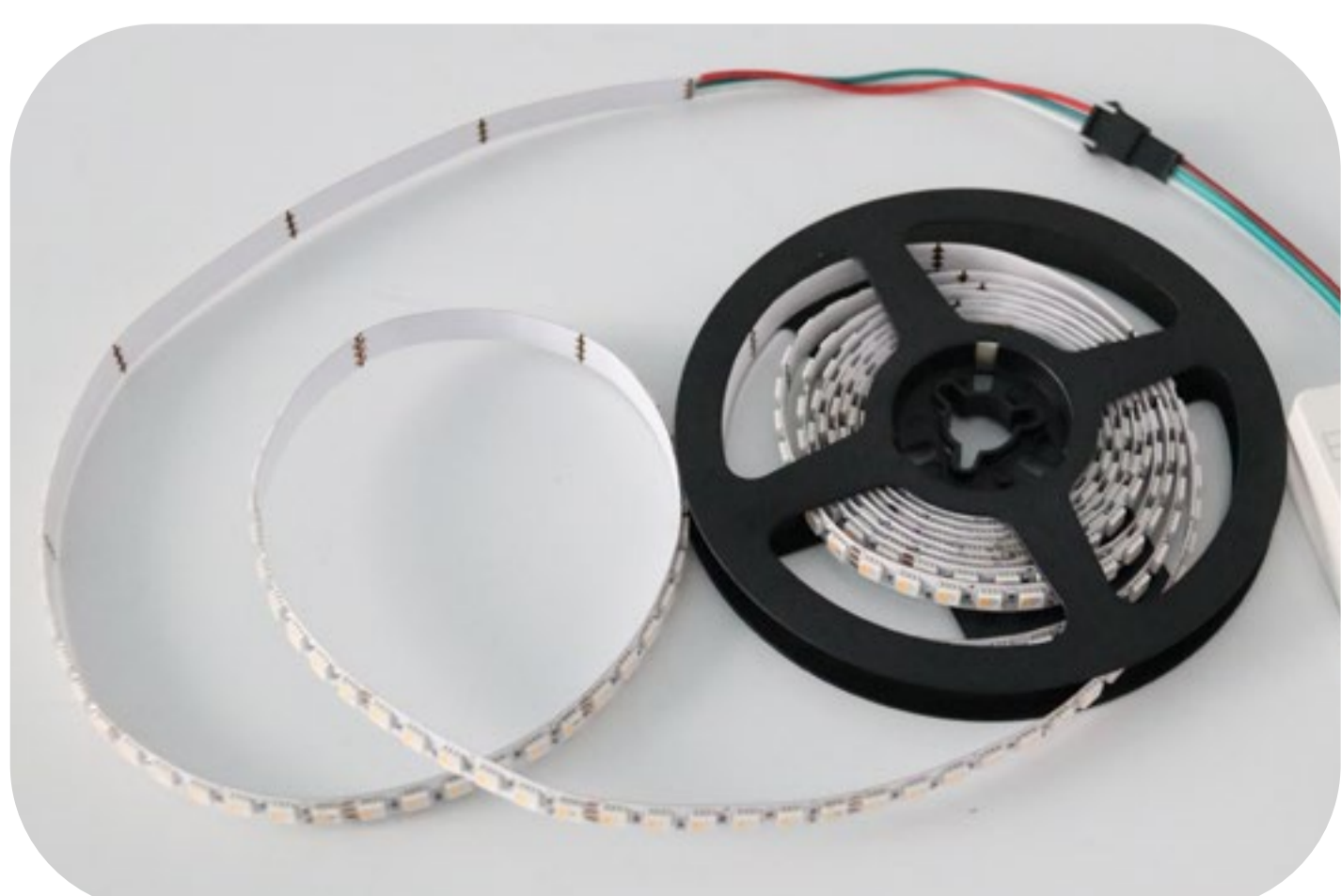

Packing Method : Reel + Boardcards  
 Quantity / Box : 5 meters / reel  
 Gross Weight :0.13 Kg ( 0.29LB)



Packing Method : Reel + boardcards  
 Quantity / Box : 20 meters / reel  
 Gross Weight : 0.84Kg (1.85LB)

**Mini Cutting Length & Connection Length**

**• Voltage (24V)**

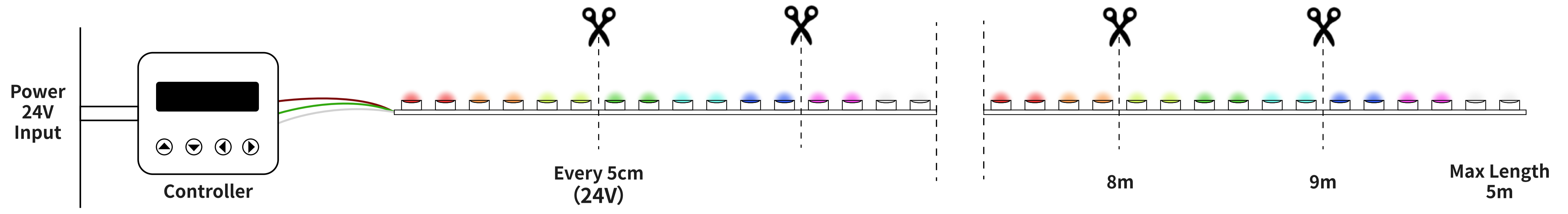

**Controller Selection**



**HC100**  
Updated version SPI magic color controller



**LT-200**  
LED Digital Controller



**SP108E LED WIFI Controller**