



Dia 13mm

MONO COLOR
12V/24V

Professional LED Light Manufacturer
Since 2008

www.wilgex-led.com

(86) 769-28820681

info@wilgex-led.com

SKU:WJ-SNF-D13-MONO-12V/24V



Structural Drawing & Bending Direction

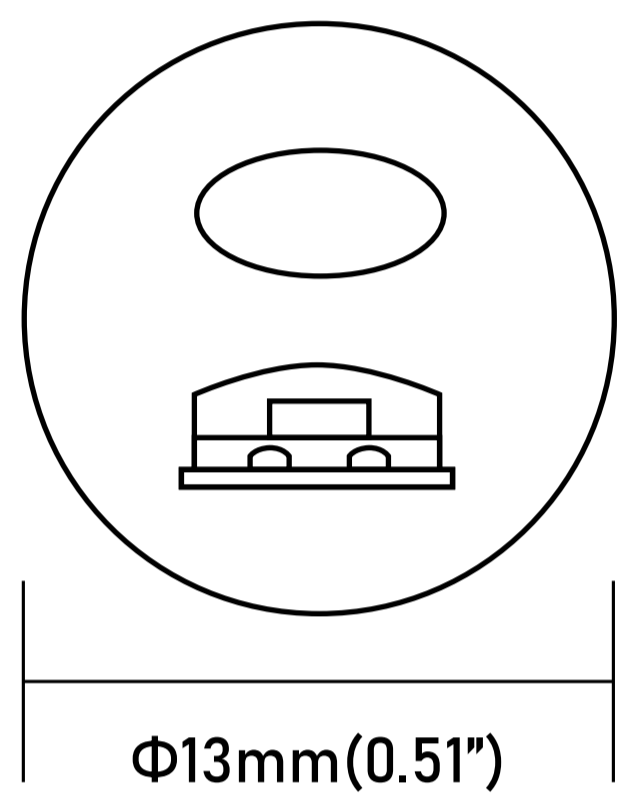

CIRCLE / LIGHT BEAM ANGLE:320°

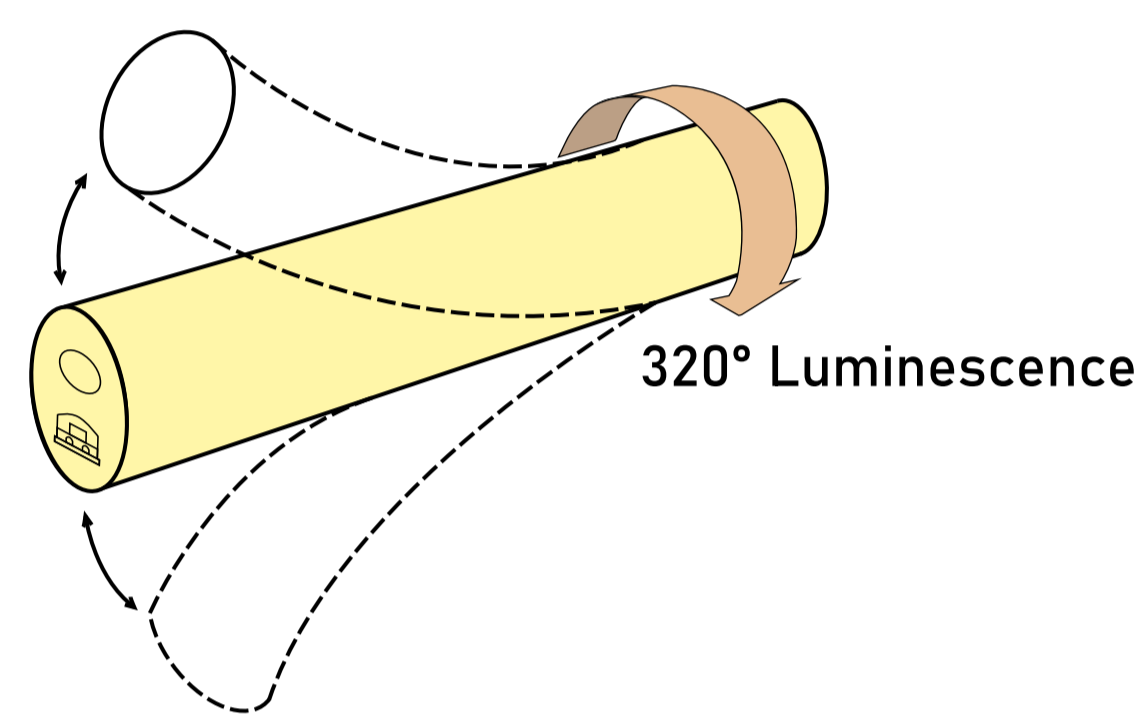

BENDING DIRECTION:
VERTICAL

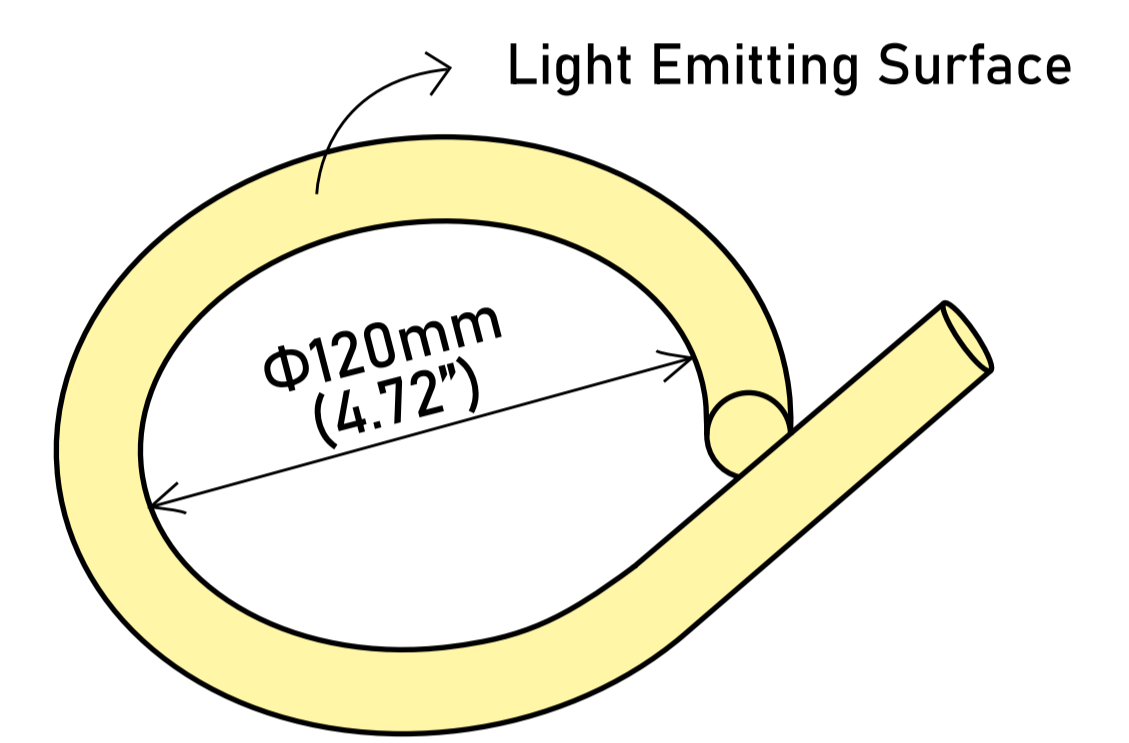

MINIMUM BENDING DIAMETER

Certifications

Technical Data

Color temperature : 2200K ● ● ● ● 10000K ALL COLOS MAX LOADING: 20m (24V) 50m (110V/220V)

COLOR	CCT/WAVE	LED QUANTITY	UNIT CUT (24V)	UNIT CUT (110V/220V)	WATTS/M (24V DOME)	LUMEN/M (24V DOME)
Warm White	2894K/584.7nm	120 LEDs/m	2.5 cm	5cm	8.40 W	518.97 lm
Cool White	10302K/472.1nm	120 LEDs/m	2.5 cm	5cm	8.39 W	465.14 lm
Red	1007K/622.9nm	120 LEDs/m	2.5 cm	5cm	7.89 W	205.3 lm
Green	8187K/526.0nm	120 LEDs/m	2.5 cm	5cm	8.45 W	525.20 lm
Blue	464.6nm	120 LEDs/m	2.5 cm	5cm	8.74 W	70.86 lm
Yellow	1909K/588.5nm	120 LEDs/m	2.5 cm	5cm	8.27 W	579.46 lm
Orange	1102K/604.8nm	120 LEDs/m	2.5 cm	5cm	8.37 W	361.79 lm
Light Pink	1535K/637.4nm	120 LEDs/m	2.5 cm	5cm	8.30 W	459.97 lm
Pink (Violet)	568nm	120 LEDs/m	2.5 cm	5cm	7.94 W	142.95 lm
Purple	452.2nm	120 LEDs/m	2.5 cm	5cm	8.08 W	89.74 lm

Optical Parameter Chart for Integrating Sphere Testing

Reliability test

TEST CATEGORY	TEST ITEMS	STANDARD/VALUE
Optical Test	Spectrum Analysis	IES LM 79(CCT, lumen, CRI, SDCM, XY, wavelength)
	Photometric Distribution	IES LM 79(lumen intensity distribution & Lux diagram)
	Lumen Maintenance & Lifetime	IES LM84 & IES TM 28
Temperature Test	Nomal Temperature Test -25°C	UL 1598 & UL2388 & IEC60598-1 & IEC60598-2-21
	Abnormal Operation Test -70°C	UL 1598 & UL2388 & IEC60598-1 & IEC60598-2-21
Physics Test	Bending Test	Manufacturer-defined, 1000 cycles
	Swing Test	UL2388, >750 cycles
	Tensile Test	Manufacturer-defined, >the weight of light in max. running length by double ends feed
	Twist Test	Manufacturer-defined, 200 cycles
	IK08	IEC62262
	Ball Impact	UL 1598 & UL2388 & IEC60598-1 & IEC60598-2-21
Weathering Test	Swimming Pool Water Immersion Test	GB9667, PH6.8-7.6, free chlorine 0.3-0.6mg/L
	Sea Water Immersion Test	IEC 60598-1, Salinity 4%
	Salt Spray Test	IEC68-2-11
	Outdoor Exposure	Manufacturer-defined
Environment Test	Flame Resistant Test	UL94
	UV Exposure Test	ASTMG154, UVA@340nm
	IPX5 IPX6 IPX7 IPX8	IEC60529
	Temperature Shock Test	Manufacturer-defined, -40°C-60°C(typical temperature range)
	Constant Temperature Test	Manufacturer-defined, 70°C(typical temperature range)

Wilgex specializes in engineering LED flexible neon lights and offers both standard and customized services. If you have specific requirements, please contact our sales department.

Four -star quality assurance

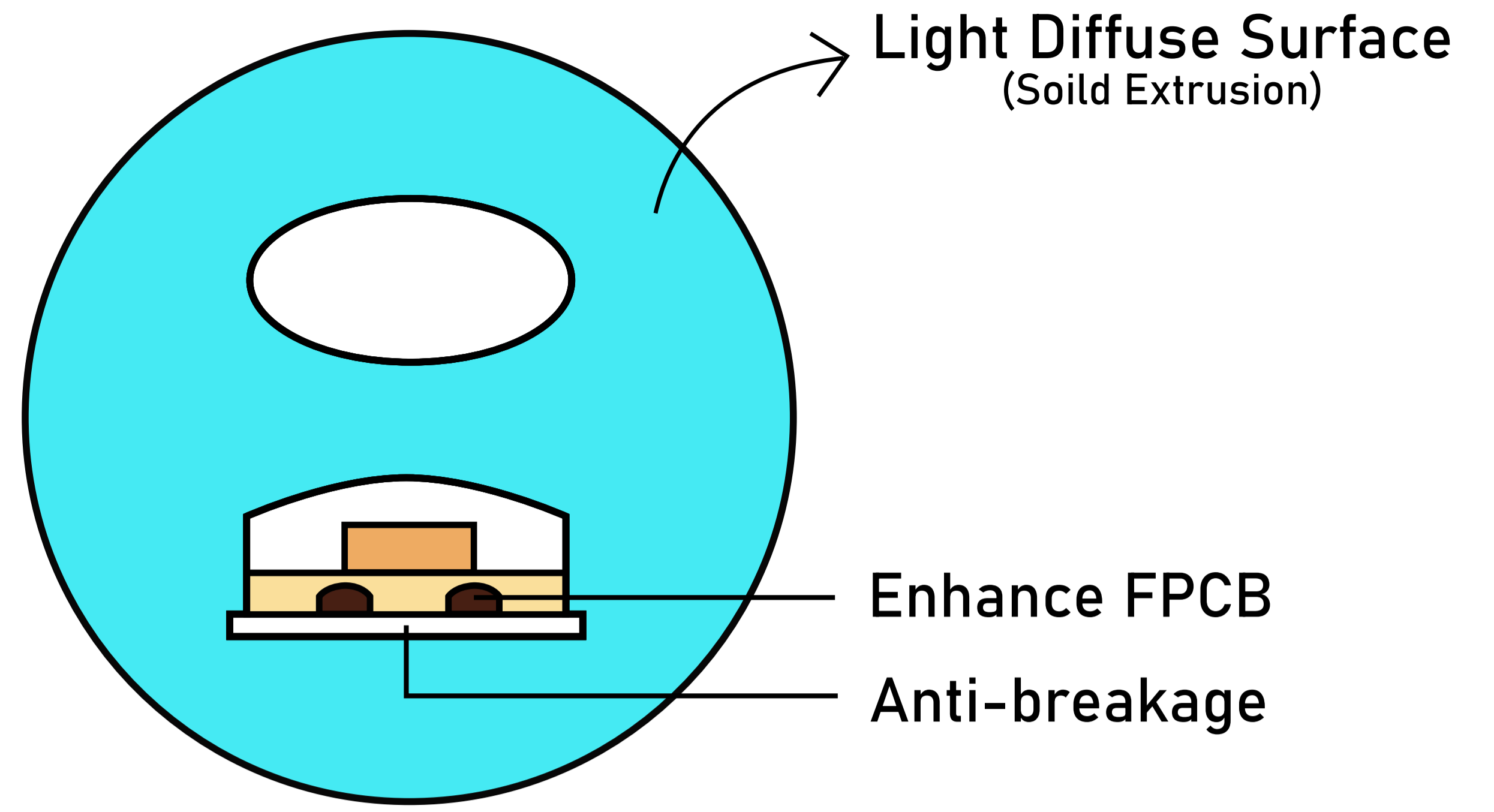

Unique Design

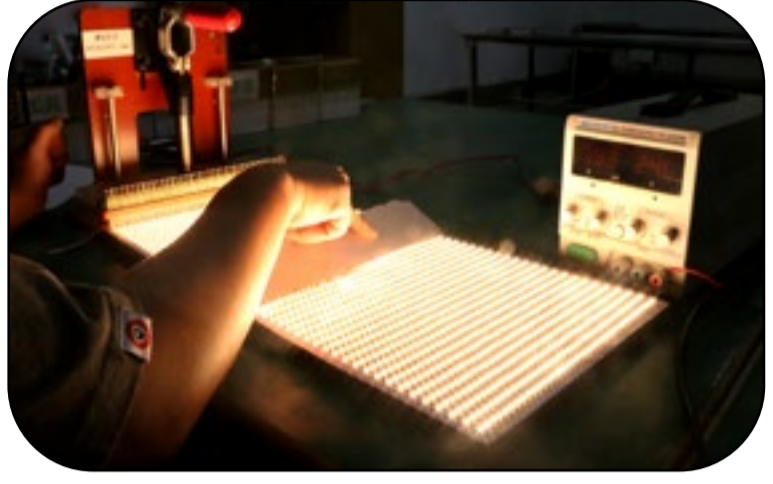

★ Enhance thickness FPC design principle



★ LED anti-death design

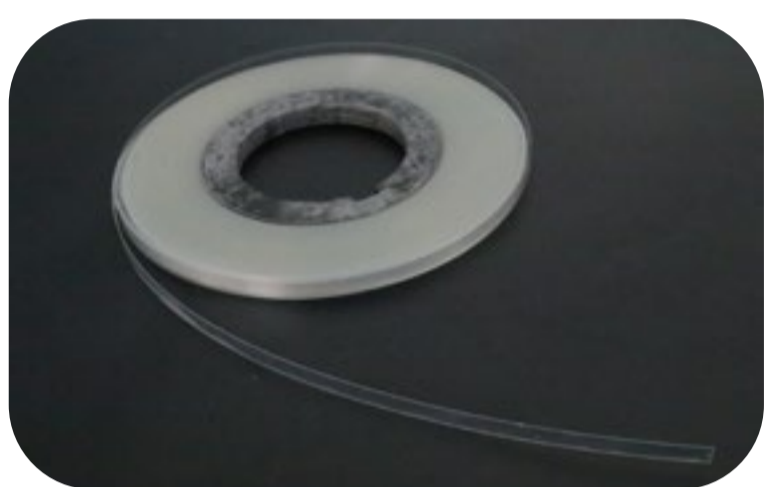

★ Add a break protection layer



★ Solid extrusion design for exterior

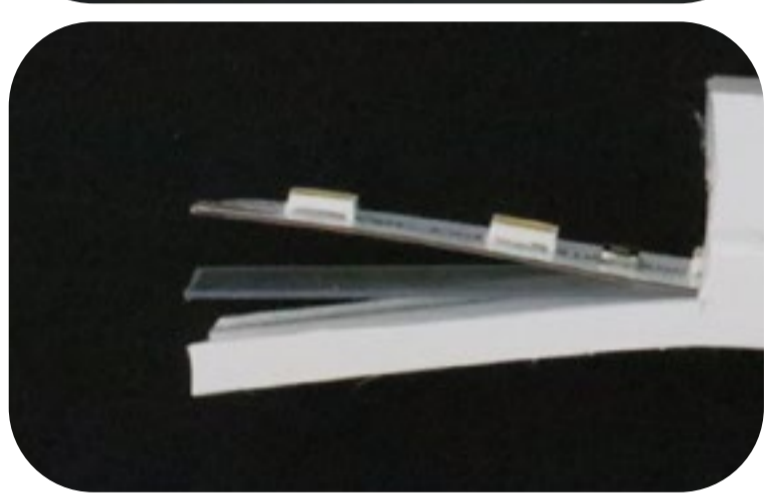

Features:

1. Size: The LED chips have a size of $\Phi 13\text{mm}$ in round shape.
2. High-density LED chips: The strips have a high density of LED chips, resulting in a brighter and more uniform light output
3. Flexible and bendable: Can be bent into various shapes and designs
4. Energy-efficient: Uses less power compared to traditional neon lights
5. Long lifespan: Can last up to 50,000 hours
6. Low heat emission: Does not emit as much heat as traditional neon lights
7. Wide color options: Available in a wide range of colors
8. Easy to install: Can be cut and connected to fit any desired length and shape
9. Durable and weather-resistant: Can withstand various weather conditions
10. Safe to use: Low voltage and does not contain hazardous materials like mercury
11. Cost-effective: Offers a cost-effective alternative to traditional neon lights.

Wide Color Options

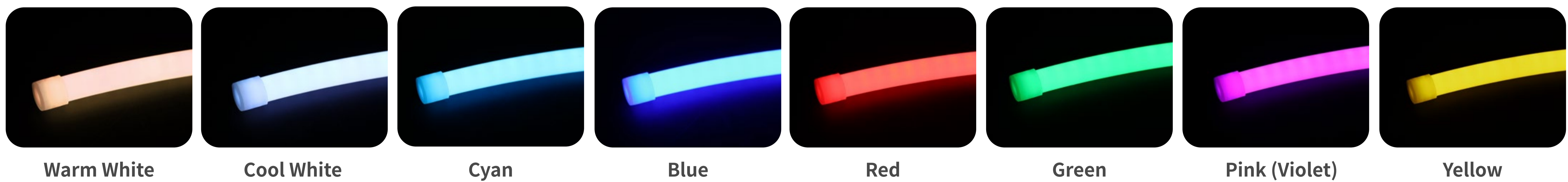

Recommended Usage Scenarios :

1. Indoor and outdoor architectural lighting decoration
2. Landscape lighting
3. Advertising signage lighting
4. Stage and theater lighting
5. Car and motorcycle lighting
6. Holiday and event lighting decoration
7. Cove lighting
8. Edge-lit lighting
9. Retail and display lighting
10. Restaurant and bar lighting

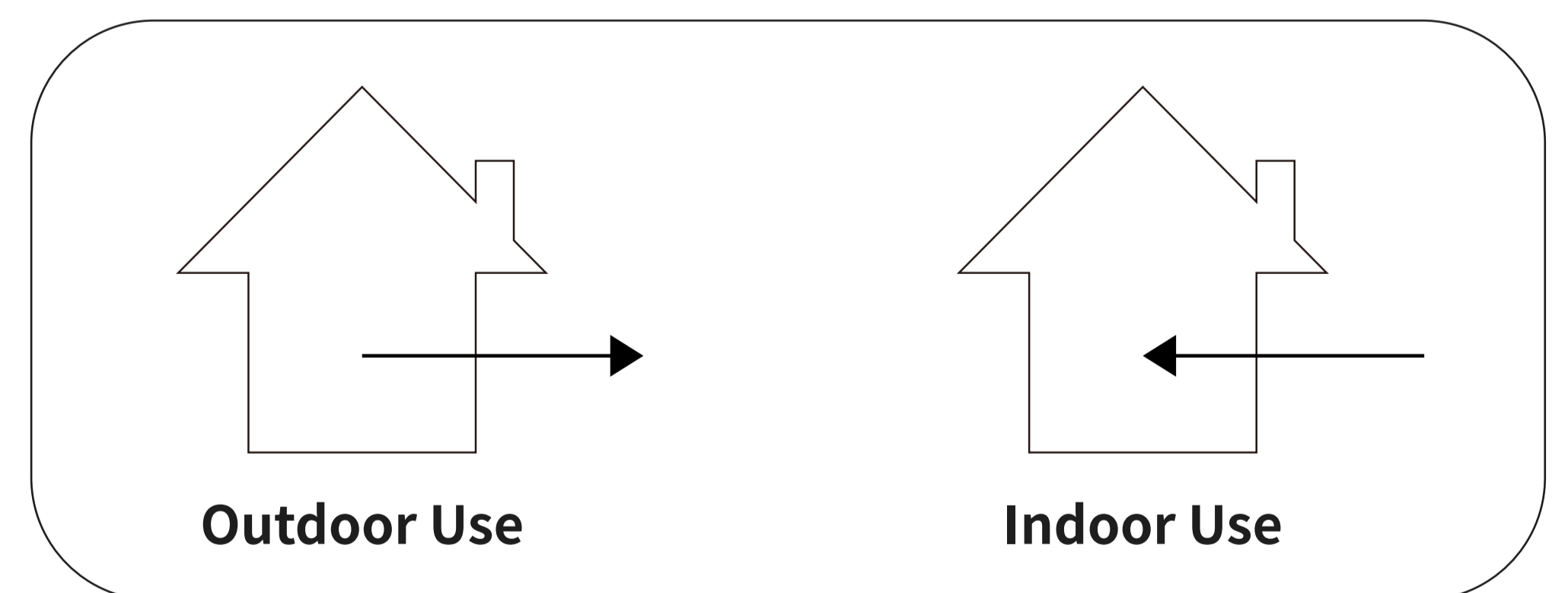

Please note that these are only recommended usage scenarios and it is important to consult the product specifications and guidelines before using flexible LED neon light strips in any application.



Package



Packing Method : Blister + White box
 Quantity / Box : 5 meters / reel
 Gross Weight :1.25Kg (2.76LB)
 Size of outer box : 52x 52x 7 cm
 CBM : 0.019m³ / box

Mini Cutting Length & Connection Length

• Voltage (12V)

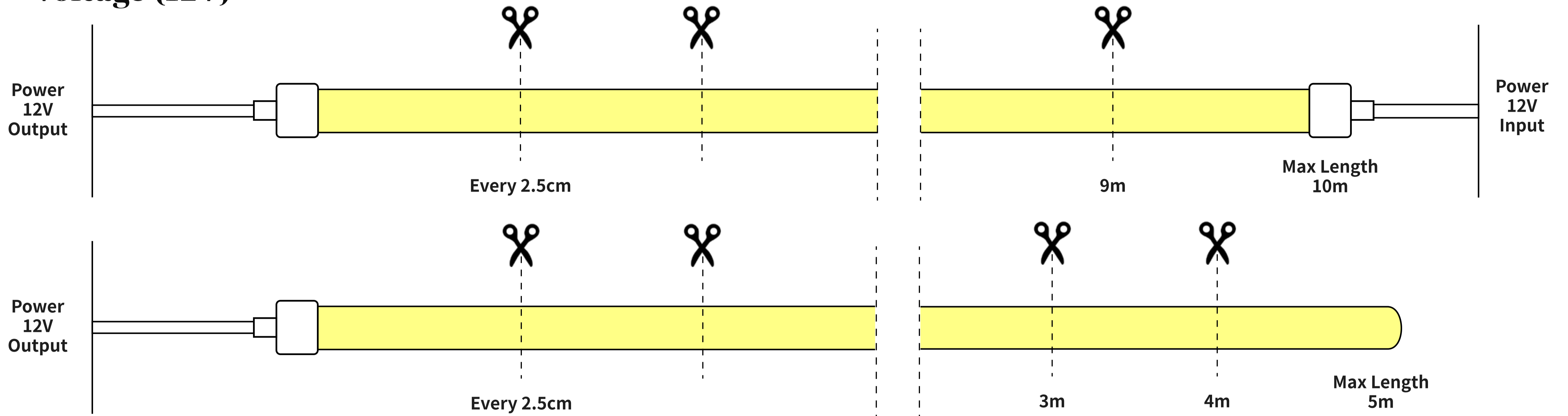

• Low Voltage (24V)

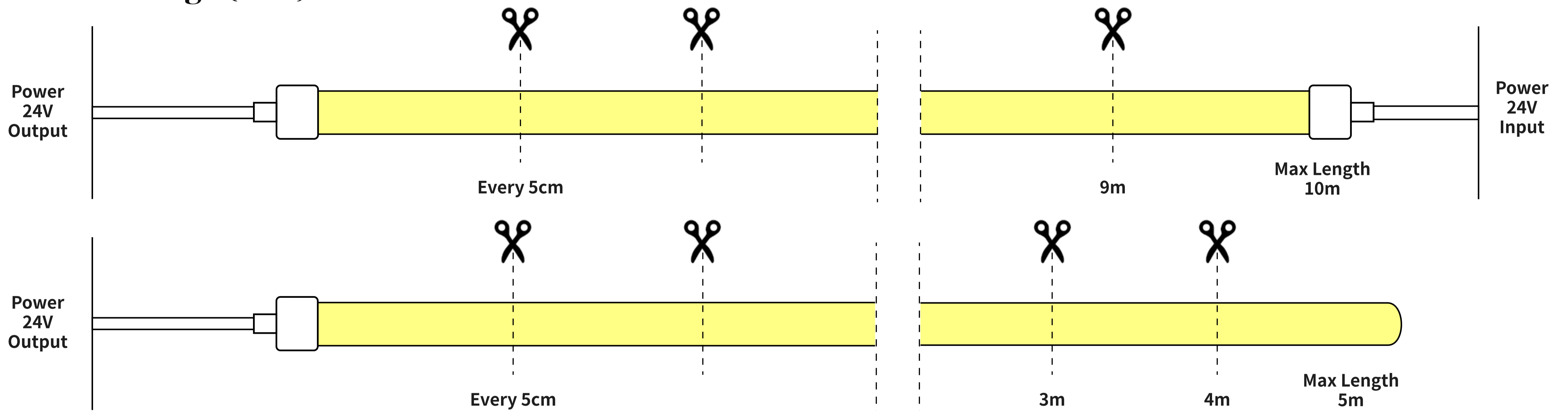

IP65 (DIY Connector)

• Voltage (12/24V)

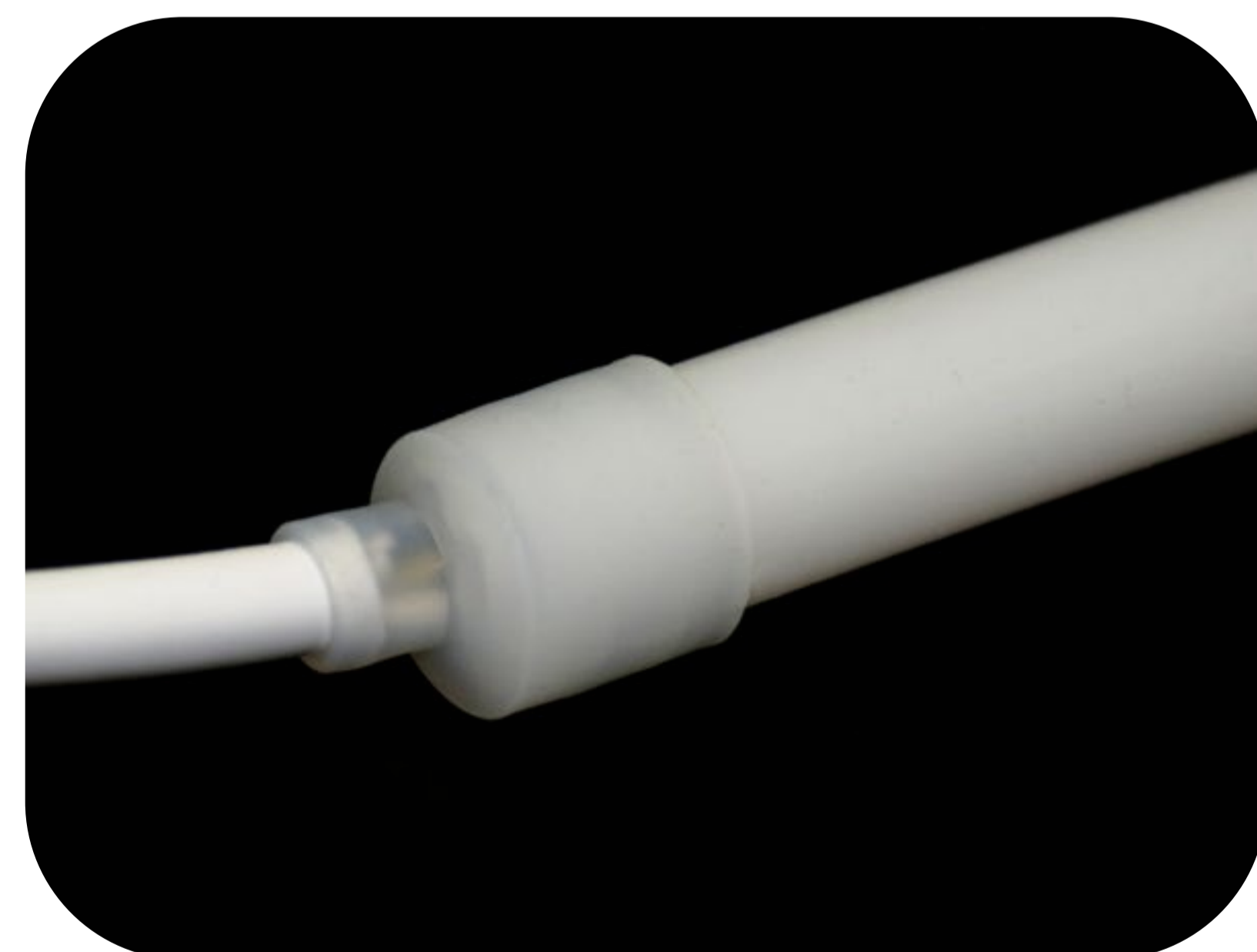

FRONT CONNECTION



END CONNECTION

• Part Details

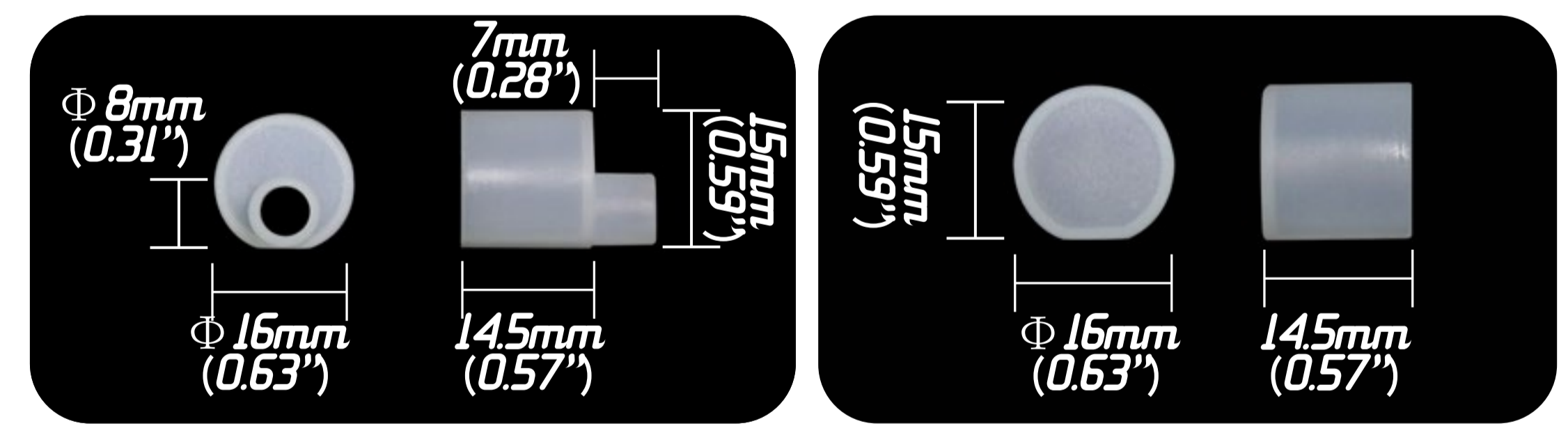

FRONT CONNECTION FITTING

TAIL FITTING

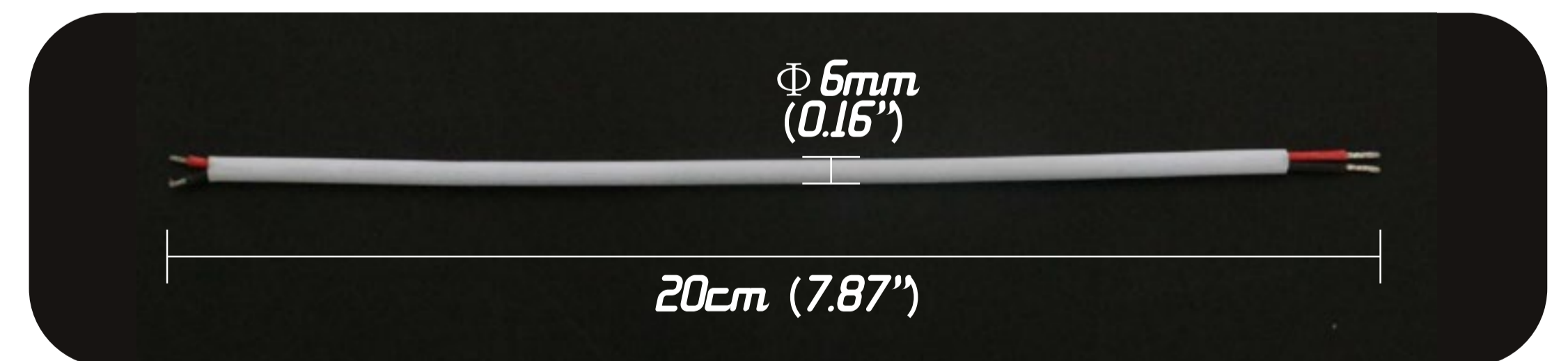

SILICONE POWER WIRE (2 CORDS)