



Professional LED Light Manufacturer
Since 2008

www.wilgex-led.com

(86) 769-28820681

info@wilgex-led.com

Dia 30mm
ROUND

LED NEON FLEX

DYNAMIC PIXEL
RGBW COLOR

12V

SKU:WJ-SNF-D30-D-RGBW-12V



Structural Drawing & Bending Direction

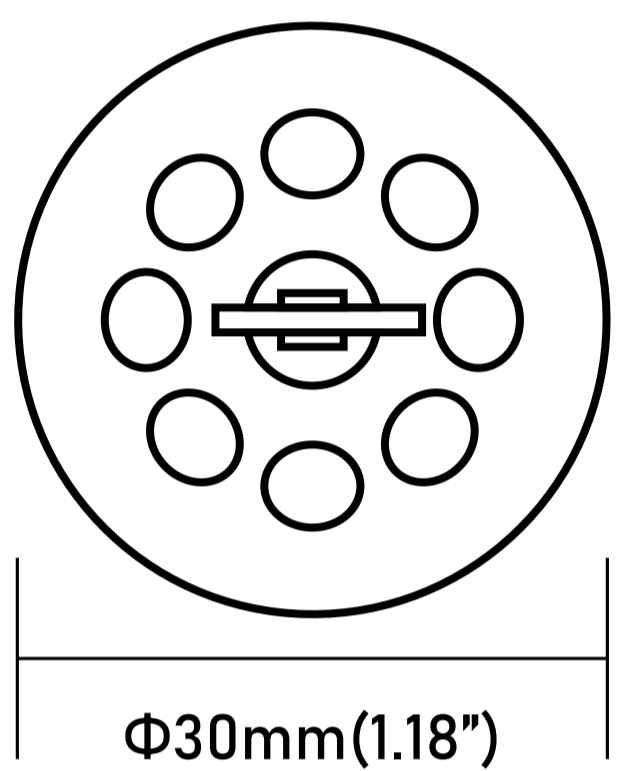

CIRCLE / LIGHT BEAM ANGLE:360°

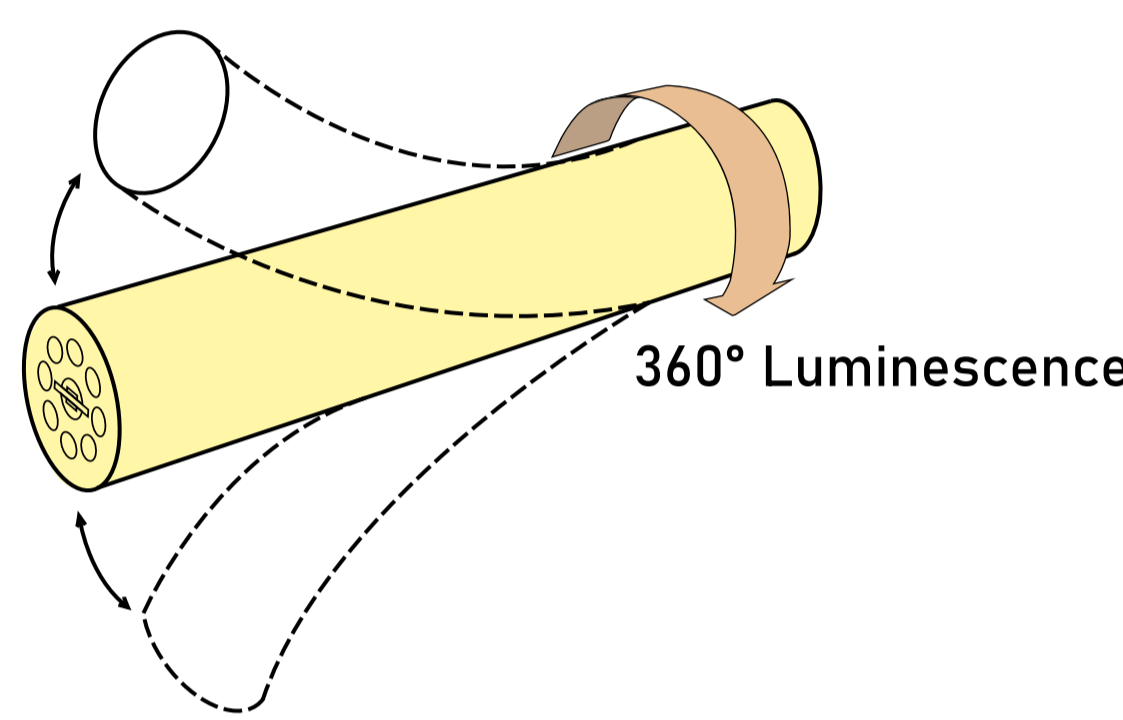

BENDING DIRECTION:
VERTICAL

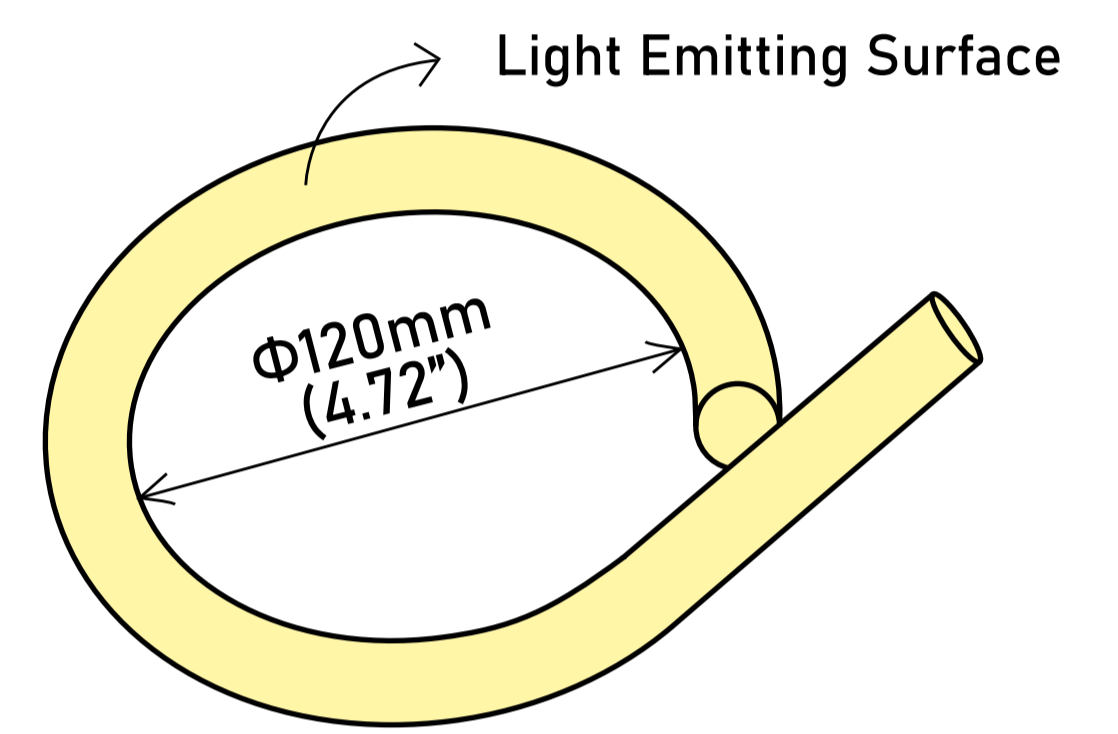

MINIMUM BENDING DIAMETER

Certifications



Technical Data



Color Temp	Red:623.8nm Green:531.0nm Blue:470.5nm White:2847K(WW)/4000K(W) RGBW:4583K (Color mixing)	Watts/m(12V Flat)	Red:8.90 W Green:8.83 W Blue:8.84 W White:16.22 W RGBW:36.70 W (Color mixing)
Lumen/m (12V Flat)	Red:121.17 lm Green:318.24 lm Blue:88.52 lm White:831.00 lm RGBW:1256.32 lm (Color mixing)	Unit Cut(12V)	2.78cm
LED Quantity(m)	2x108 LEDs + 36 ICs	Max Loading(12V)	5m
			IC code: WS2811F (compatible with all ICs and controllers in the WS2811, 1804, and 1809 series)

Optical Parameter Chart for Integrating Sphere Testing

Chroma Parameters
Chro.Coor.: x=0.3567 y=0.3539 u=0.2184 v=0.3250 duv=-0.0034
CCT: Tc= 4583K Dominant Wave.: 580.6nm Purity: 13.2%
Flux Ratio: R=21.7%,G=73.3%,B=4.9% Peak Wave.: 467.1nm Half Width: 25.7nm

Bending Index: Ra= 82.2
R1 =78.0 R2 =84.0 R3 =91.9 R4 =82.5 R5 =80.3 R6 =77.3 R7 =84.7
R8 =78.9 R9 =49.1 R10=67.8 R11=80.5 R12=66.3 R13=77.7 R14=95.6
R15=78.1

Photo Parameters
Flux: 1257.30lm Effi.: 34.2lm/W Radiant: 4120.8mW Iv: 0.0mcd

Ele. Parameters
Voltage:U=12.000V Current:I=3.0560A
Power:P=36.70W Power Factor:PF=1.000

Reliability test

TEST CATEGORY	TEST ITEMS	STANDARD/VALUE
Optical Test	Spectrum Analysis	IES LM 79(CCT, lumen, CRI, SDCM, XY, wavelength)
	Photometric Distribution	IES LM 79(lumen intensity distribution & Lux diagram)
Temperature Test	Lumen Maintenance & Lifetime	IES LM84 & IES TM 28
	Nomal Temperature Test -25°C	UL 1598 & UL2388 & IEC60598-1 & IEC60598-2-21
	Abnormal Operation Test -70°C	UL 1598 & UL2388 & IEC60598-1 & IEC60598-2-21
Physics Test	Bending Test	Manufacturer-defined, 1000 cycles
	Swing Test	UL2388, >750 cycles
	Tensile Test	Manufacturer-defined, >the weight of light in max. running length by double ends feed
	Twist Test	Manufacturer-defined, 200 cycles
	IK08	IEC62262
Weathering Test	Ball Impact	UL 1598 & UL2388 & IEC60598-1 & IEC60598-2-21
	Swimming Pool Water Immersion Test	GB9667, PH6.8-7.6, free chlorine 0.3-0.6mg/L
	Sea Water Immersion Test	IEC 60598-1, Salinity 4%
	Salt Spray Test	IEC68-2-11
Environment Test	Outdoor Exposure	Manufacturer-defined
	Flame Resistant Test	UL94
	UV Exposure Test	ASTMG154, UVA@340nm
	IPX5 IPX6 IPX7 IPX8	IEC60529
	Temperature Shock Test	Manufacturer-defined, -40°C-60°C(typical temperature range)
Constant Temperature Test	Manufacturer-defined, 70°C(typical temperature range)	

Wilgex specializes in engineering LED flexible neon lights and offers both standard and customized services. If you have specific requirements, please contact our sales department.

Four-star quality assurance

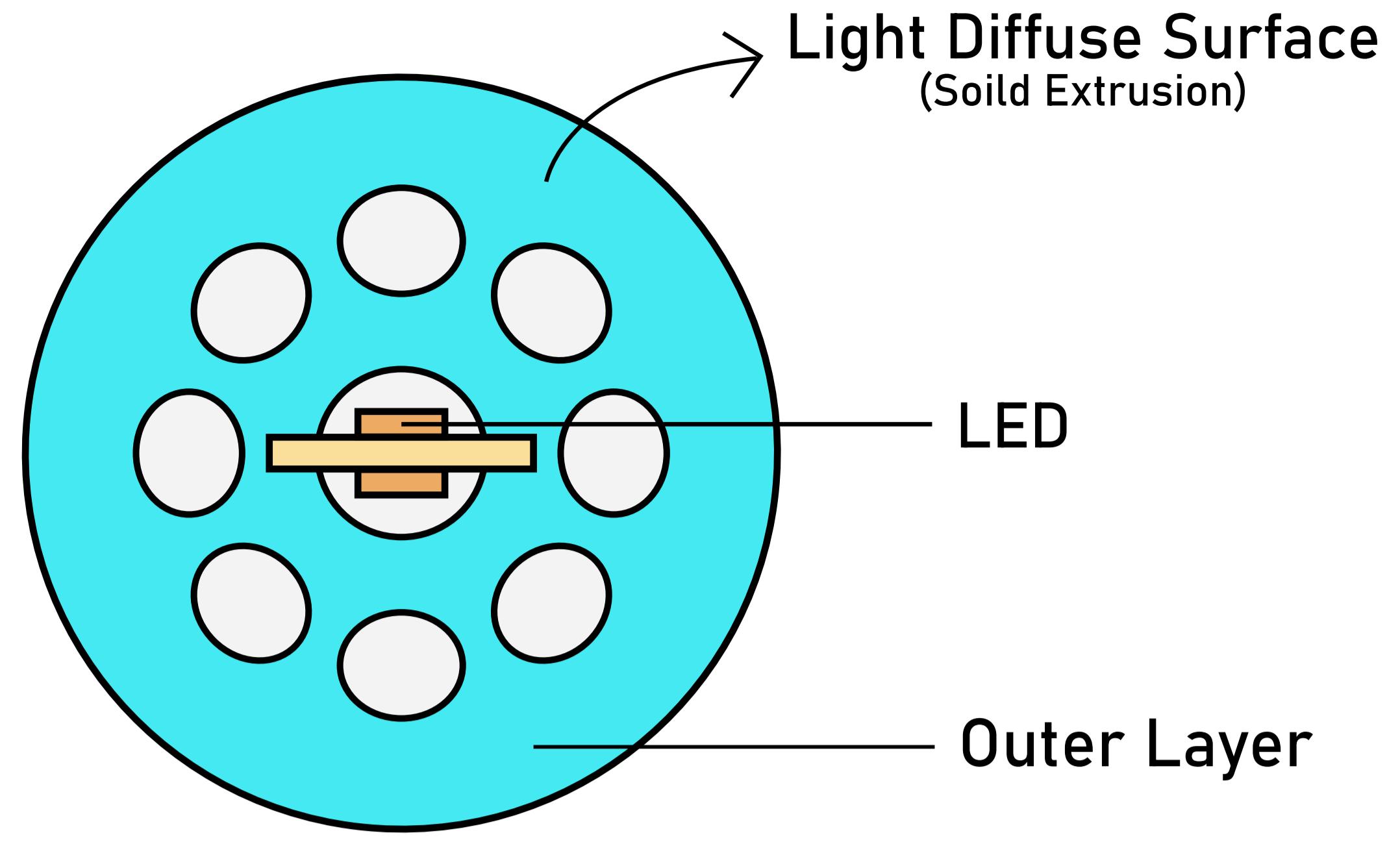
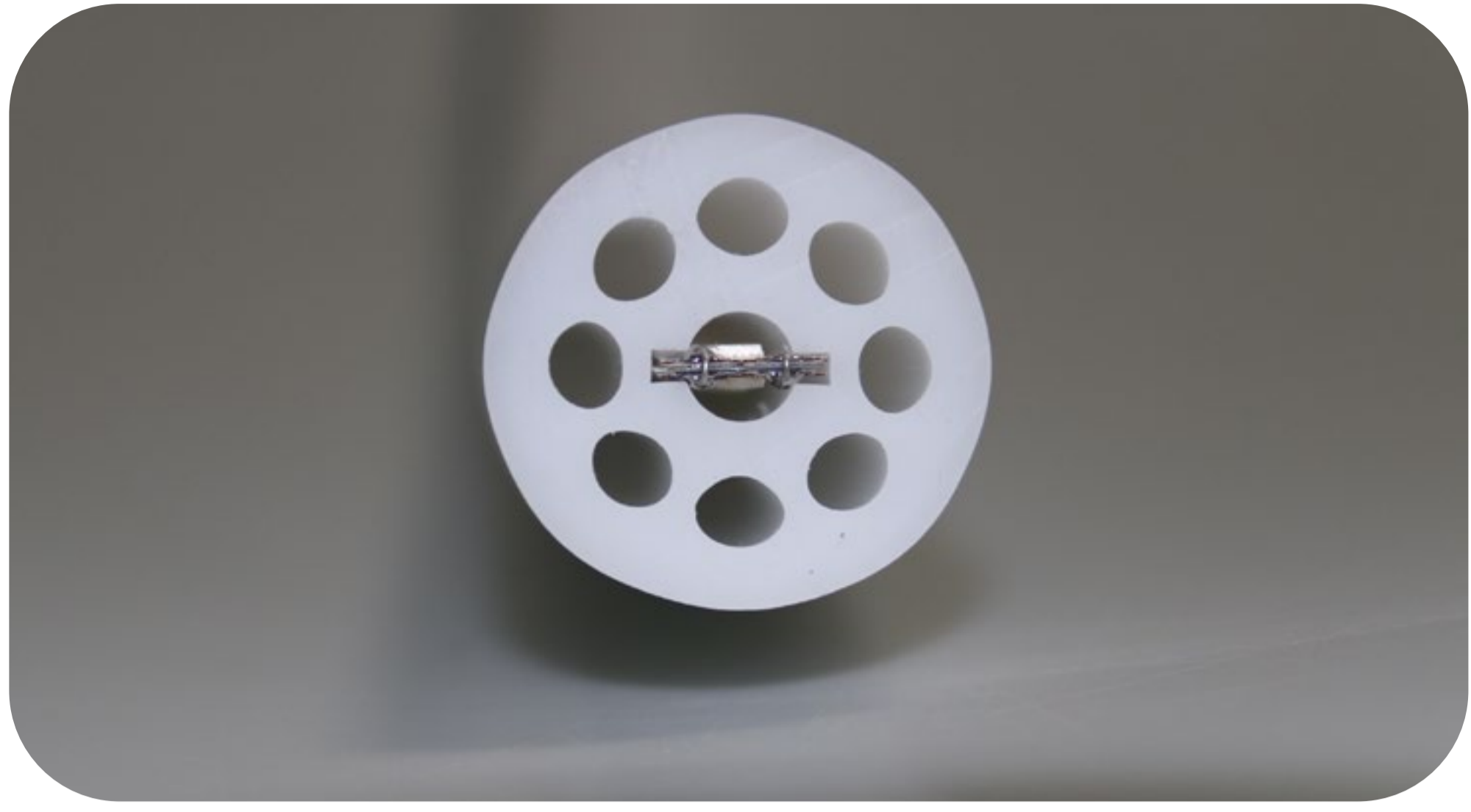

Unique Design

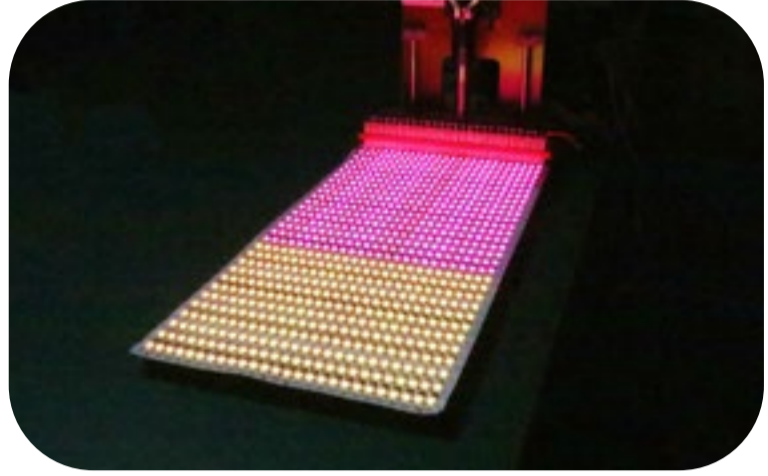

★ Enhance thickness FPC design principle

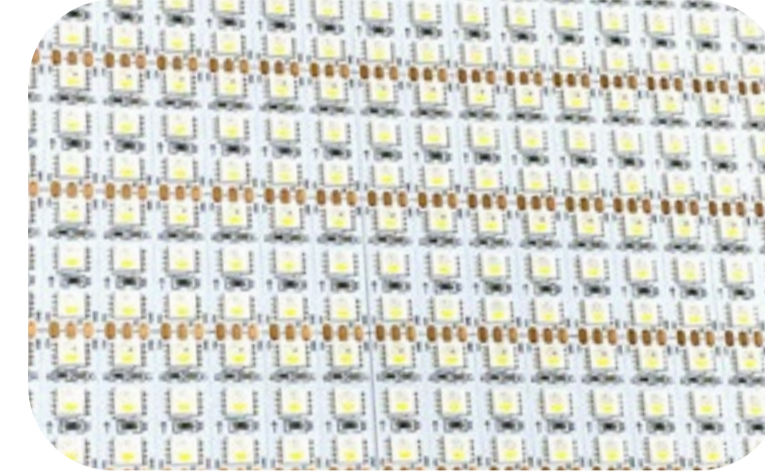

★ LED anti-death design

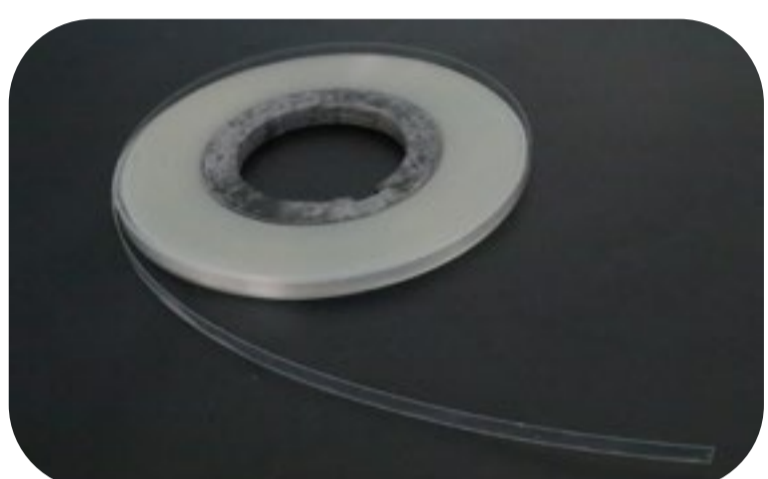

★ Add a break protection layer



★ Solid extrusion design for exterior

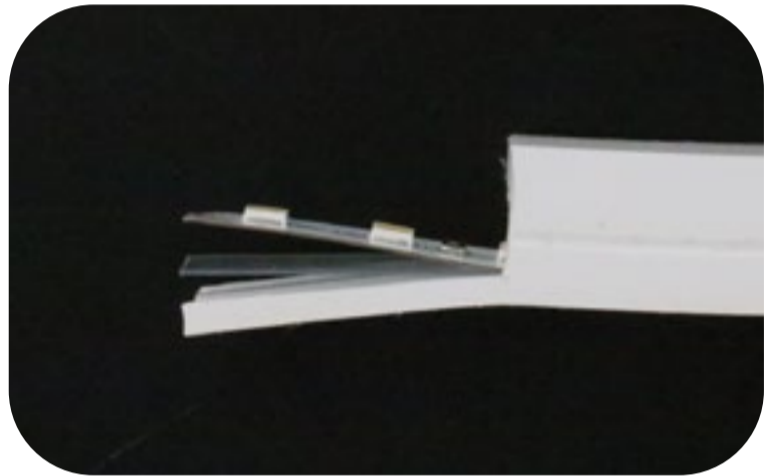

Features:

1. Size: The LED chips have a size of $\Phi 30\text{mm}$ in round shape.
2. High-density LED chips: The strips have a high density of LED chips, resulting in a brighter and more uniform light output
3. Flexible and bendable: Can be bent into various shapes and designs
4. Energy-efficient: Uses less power compared to traditional neon lights
5. Long lifespan: Can last up to 50,000 hours
6. Low heat emission: Does not emit as much heat as traditional neon lights
7. Wide color options: Available in a wide range of colors
8. Easy to install: Can be cut and connected to fit any desired length and shape
9. Durable and weather-resistant: Can withstand various weather conditions
10. Safe to use: Low voltage and does not contain hazardous materials like mercury
11. Cost-effective: Offers a cost-effective alternative to traditional neon lights.

Wide Color Options

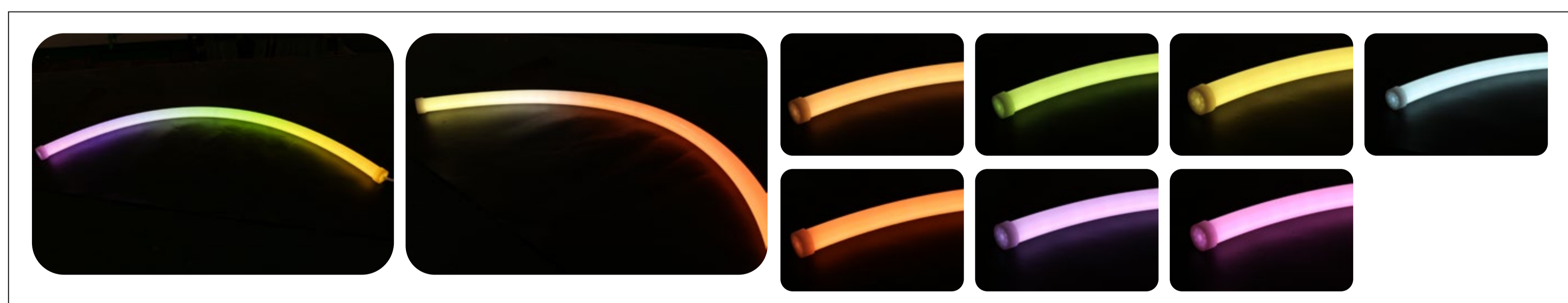

Dynamic Pixel RGBW

Recommended Usage Scenarios :

1. Indoor and outdoor architectural lighting decoration
2. Landscape lighting
3. Advertising signage lighting
4. Stage and theater lighting
5. Car and motorcycle lighting
6. Holiday and event lighting decoration
7. Cove lighting
8. Edge-lit lighting
9. Retail and display lighting
10. Restaurant and bar lighting

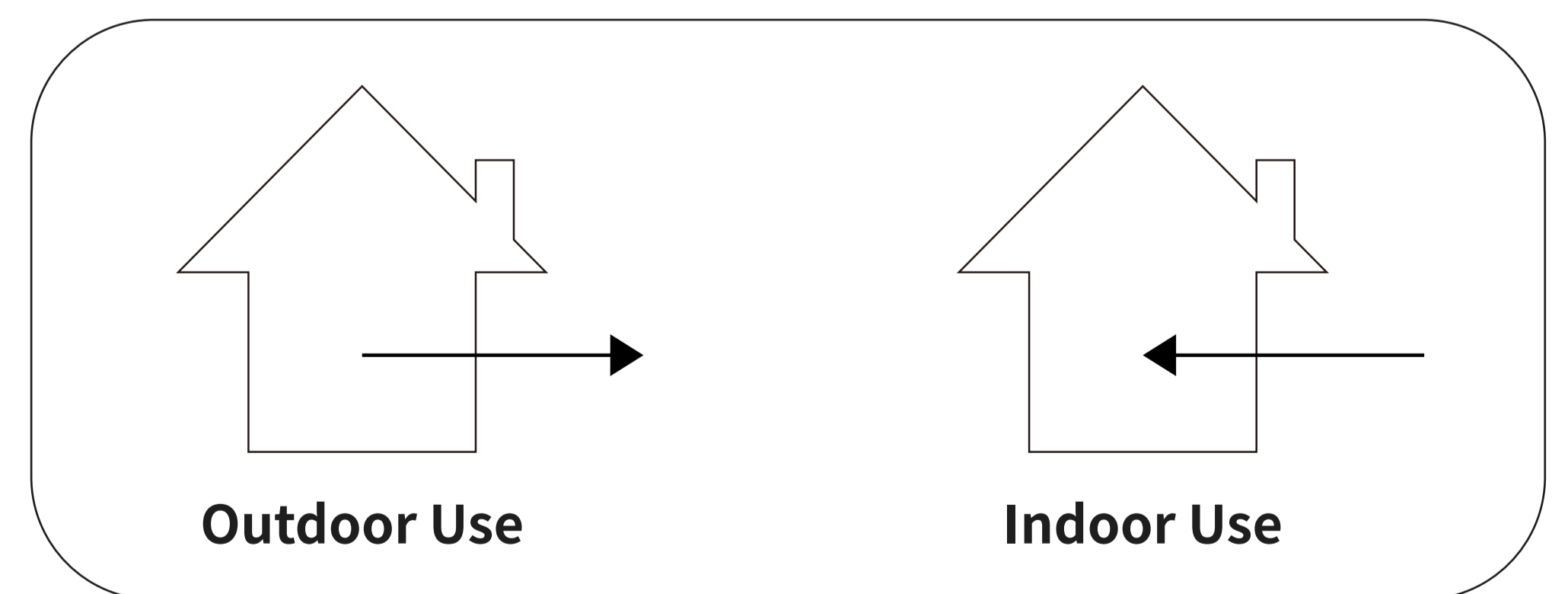

Please note that these are only recommended usage scenarios and it is important to consult the product specifications and guidelines before using flexible LED neon light strips in any application.

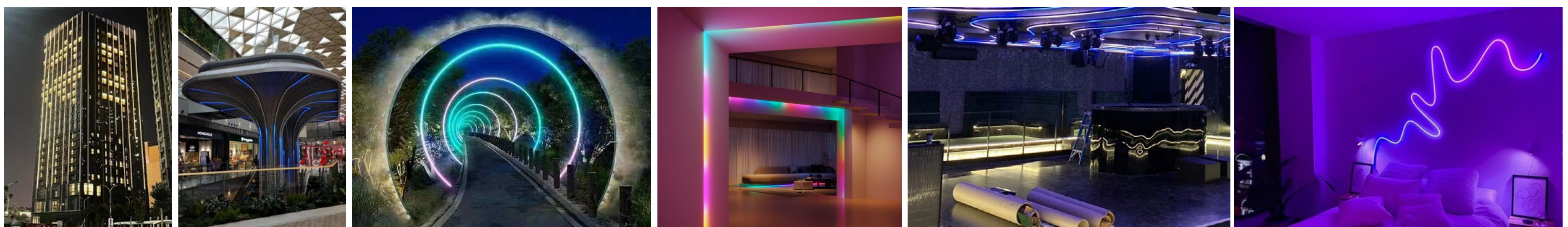

Package



Packing Method : Blister + White box
 Quantity / Box : 5 meters / reel
 Gross Weight :3.62 Kg (7.98LB)
 Size of outer box : 52x 52x 7 cm
 CBM : 0.019m³ / box

Mini Cutting Length & Connection Length

• Voltage (12V)

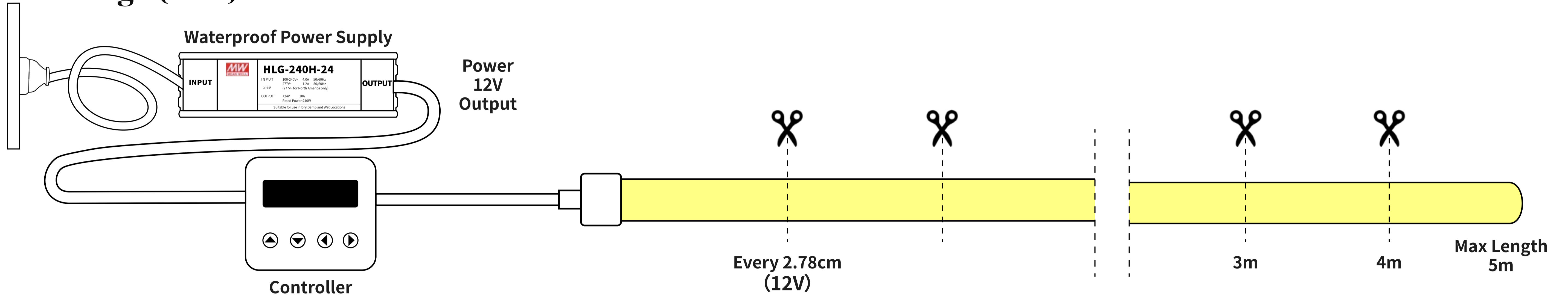

Controller



SP108E LED WIFI Controller

IP65 (DIY Connector)

• Voltage (24V)



FRONT CONNECTION



END CONNECTION

• Part Details

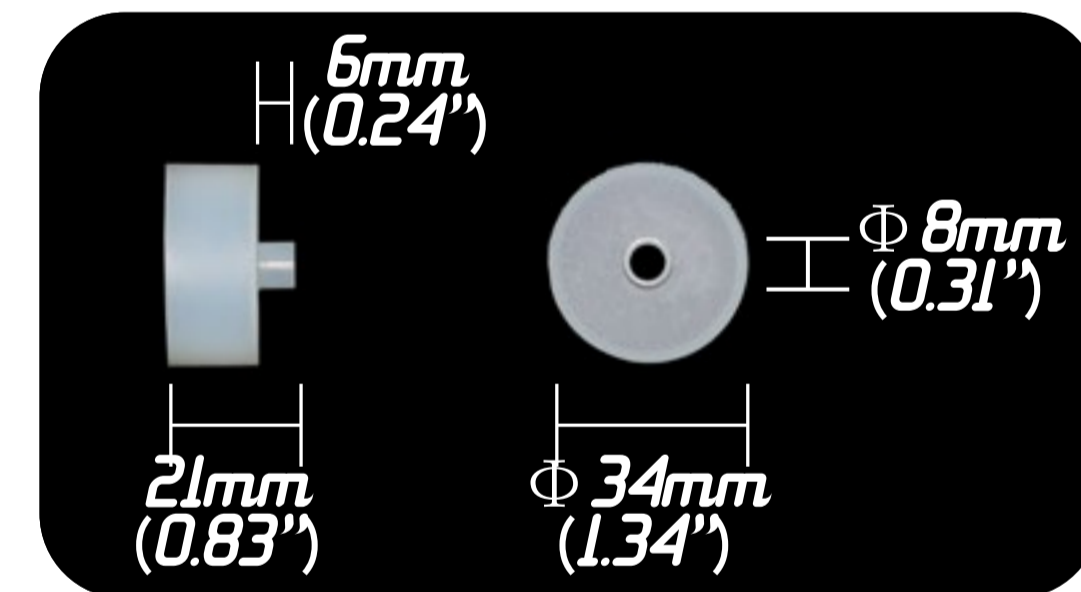

FRONT CONNECTION FITTING

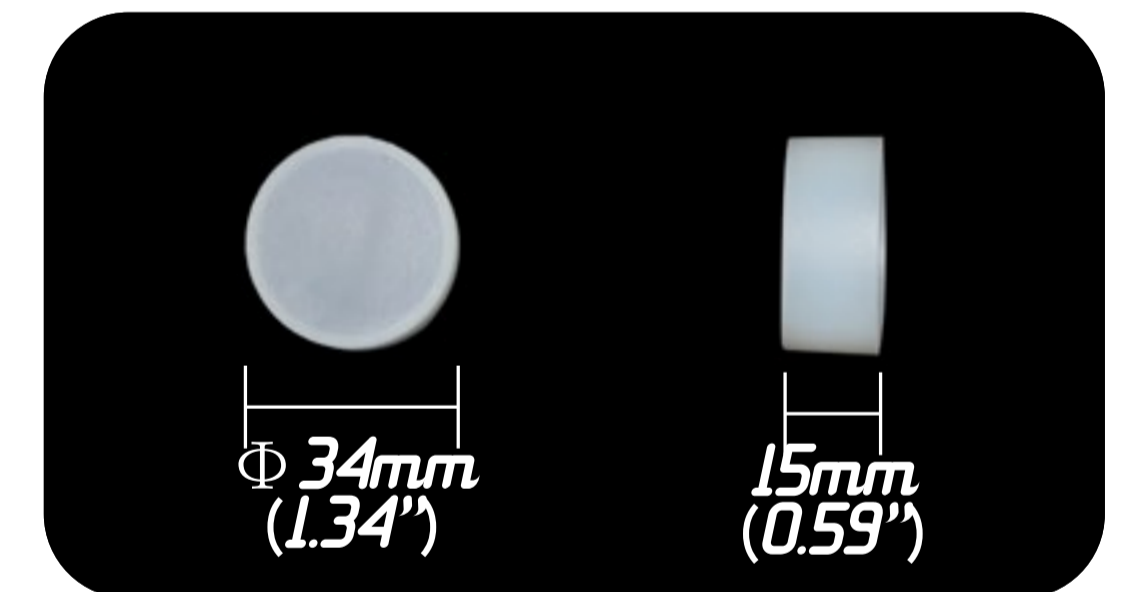

TAIL FITTING



SILICONE POWER WIRE (3 CORDS)

Mounting Plastic Transparent Channel

