

Wilgex[®]

Professional LED Light Manufacturer
Since 2008

www.wilgex-led.com

(86) 769-28820681

info@wilgex-led.com

LED NEON FLEX

20x20mm
FLAT

RGB COLOR
12V/24V



Structural Drawing & Bending Direction

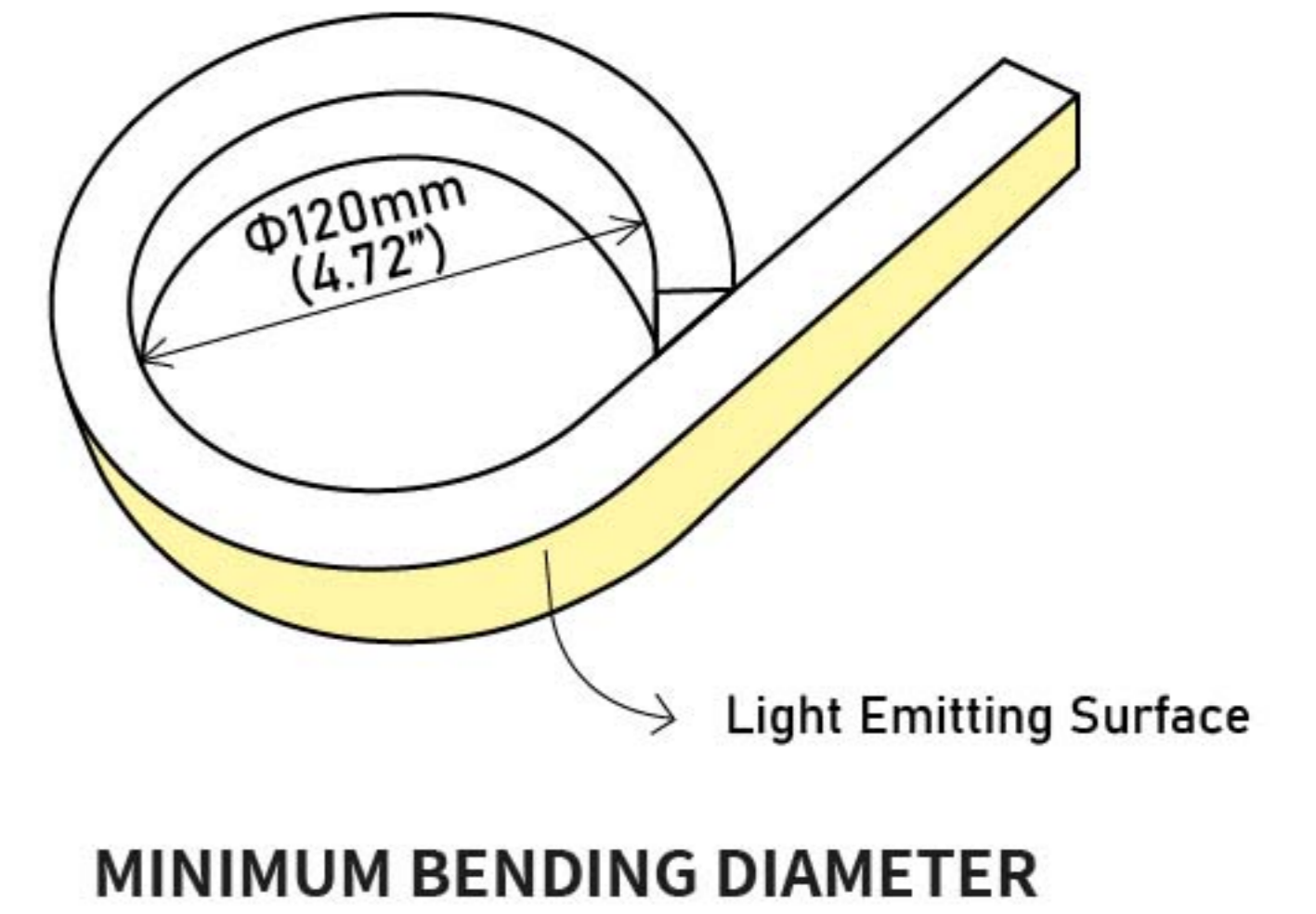
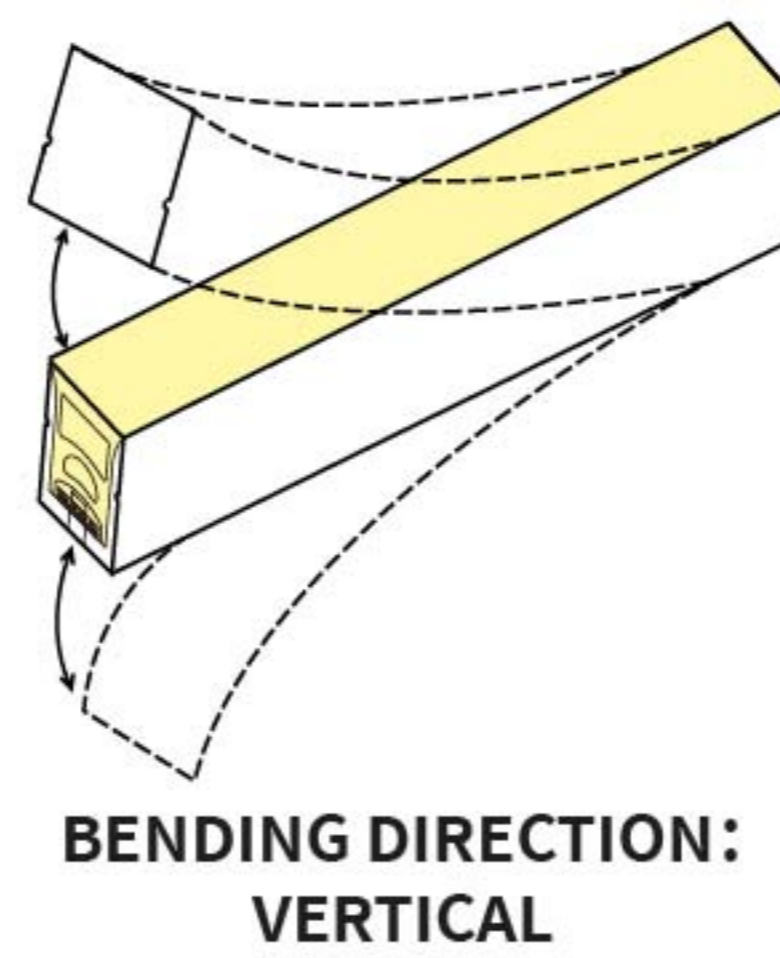
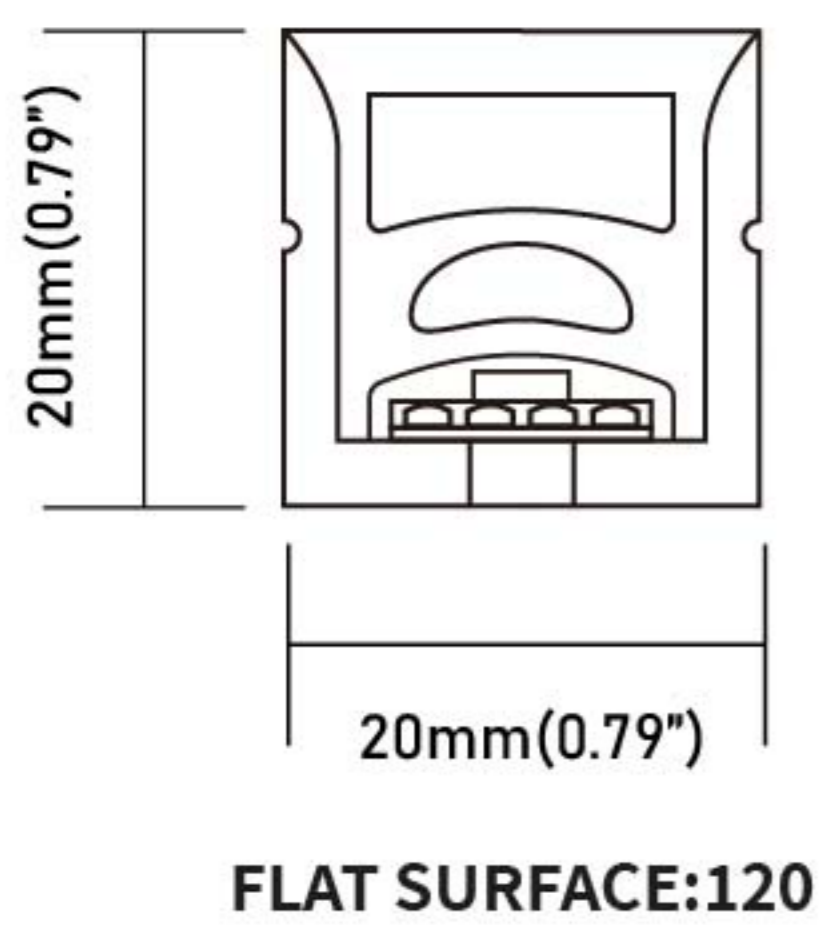

Certifications



Technical Data

PWM-RGB



Color Temp	Red: 623.5nm Green: 524.9nm Blue: 469.9nm White: 6500K(Color mixing)	Watts/m(24V Flat)	Red: 5.20 W Green: 5.99 W Blue: 6.44 W White: 17.23 W(Color mixing)
Lumen/m (24V Flat)	Red: 88.57 lm Green: 167.66 lm Blue: 31.73 lm White: 264.03 lm(Color mixing)	Unit Cut(24V)	5.56cm
LED Quantity(m)	108 LEDs	Max Loading(24V)	5m

Optical Parameter Chart for Integrating Sphere Testing

Chroma Parameters
Chro.Coord.: x=0.2572 y=0.2583 u=0.1842 v=0.2775 duv=-0.0002
CCT: Tc=19471K Dominant Wave.: 478.3nm Purity: 32.9%
Flux Ratio: R=24.0%,G=65.0%,B=11.0% Peak Wave.: 464.7nm Half Width: 22.8nm

Rending Index: Ra= 30.9
R1 =11.5 R2 =42.4 R3 =65.0 R4 =35.5 R5 =36.6 R6 =42.1 R7 =44.7
R8 =-30.0 R9 =-286.4R10=-35.0 R11=27.1 R12=46.7 R13=14.3 R14=75.9
R15=-12.4

Photo Parameters
Flux: 264.12lm Effi.: 15.3lm/W Radiant: 1348.0mW Iv: 0.0mcd

Ele. Parameters
Voltage:U=24.000V Current:I=0.7170A
Power:P=17.23W Power Factor:PF=1.000

Reliability test

TEST CATEGORY	TEST ITEMS	STANDARD/VALUE
Optical Test	Spectrum Analysis	IES LM 79(CCT, lumen, CRI, SDCM, XY, wavelength)
	Photometric Distribution	IES LM 79(lumen intensity distribution & Lux diagram)
	Lumen Maintenance & Lifetime	IES LM84 & IES TM 28
Temperature Test	Nomal Temperature Test -25°C	UL 1598 & UL2388 & IEC60598-1 & IEC60598-2-21
	Abnormal Operation Test -70°C	UL 1598 & UL2388 & IEC60598-1 & IEC60598-2-21
Physics Test	Bending Test	Manufacturer-defined, 1000 cycles
	Swing Test	UL2388, >750 cycles
	Tensile Test	Manufacturer-defined, >the weight of light in max. running length by double ends feed
	Twist Test	Manufacturer-defined, 200 cycles
	IK08	IEC62262
Weathering Test	Ball Impact	UL 1598 & UL2388 & IEC60598-1 & IEC60598-2-21
	Swimming Pool Water Immersion Test	GB9667, PH6.8-7.6, free chlorine 0.3-0.6mg/L
	Sea Water Immersion Test	IEC 60598-1, Salinity 4%
	Salt Spray Test	IEC68-2-11
Environment Test	Outdoor Exposure	Manufacturer-defined
	Flame Resistant Test	UL94
	UV Exposure Test	ASTMG154, UVA@340nm
	IPX5 IPX6 IPX7 IPX8	IEC60529
	Temperature Shock Test	Manufacturer-defined, -40°C-60°C(typical temperature range)
Constant Temperature Test	Manufacturer-defined, 70°C(typical temperature range)	

Wilgex specializes in engineering LED flexible neon lights and offers both standard and customized services. If you have specific requirements, please contact our sales department.

Four-star quality assurance

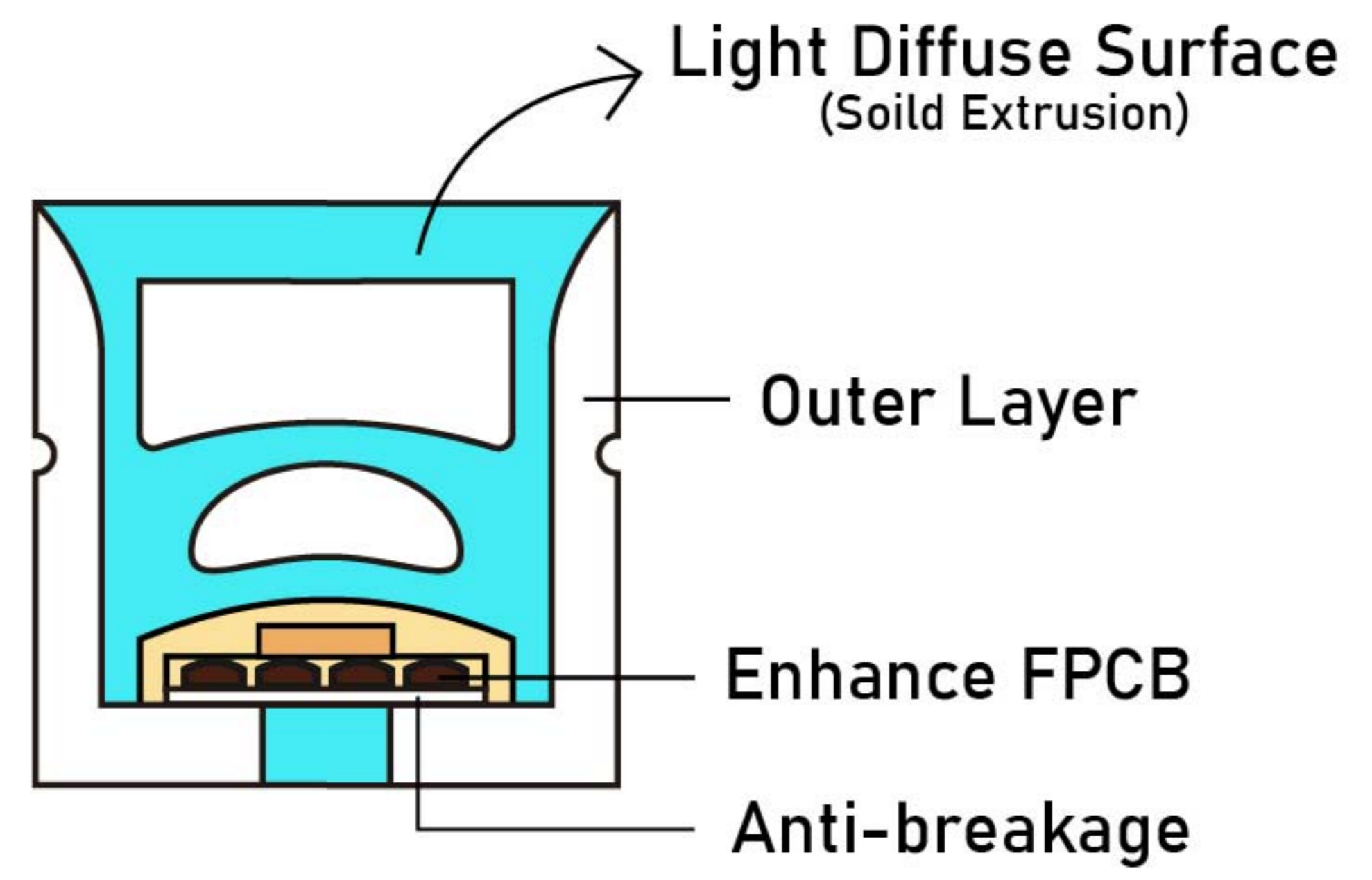
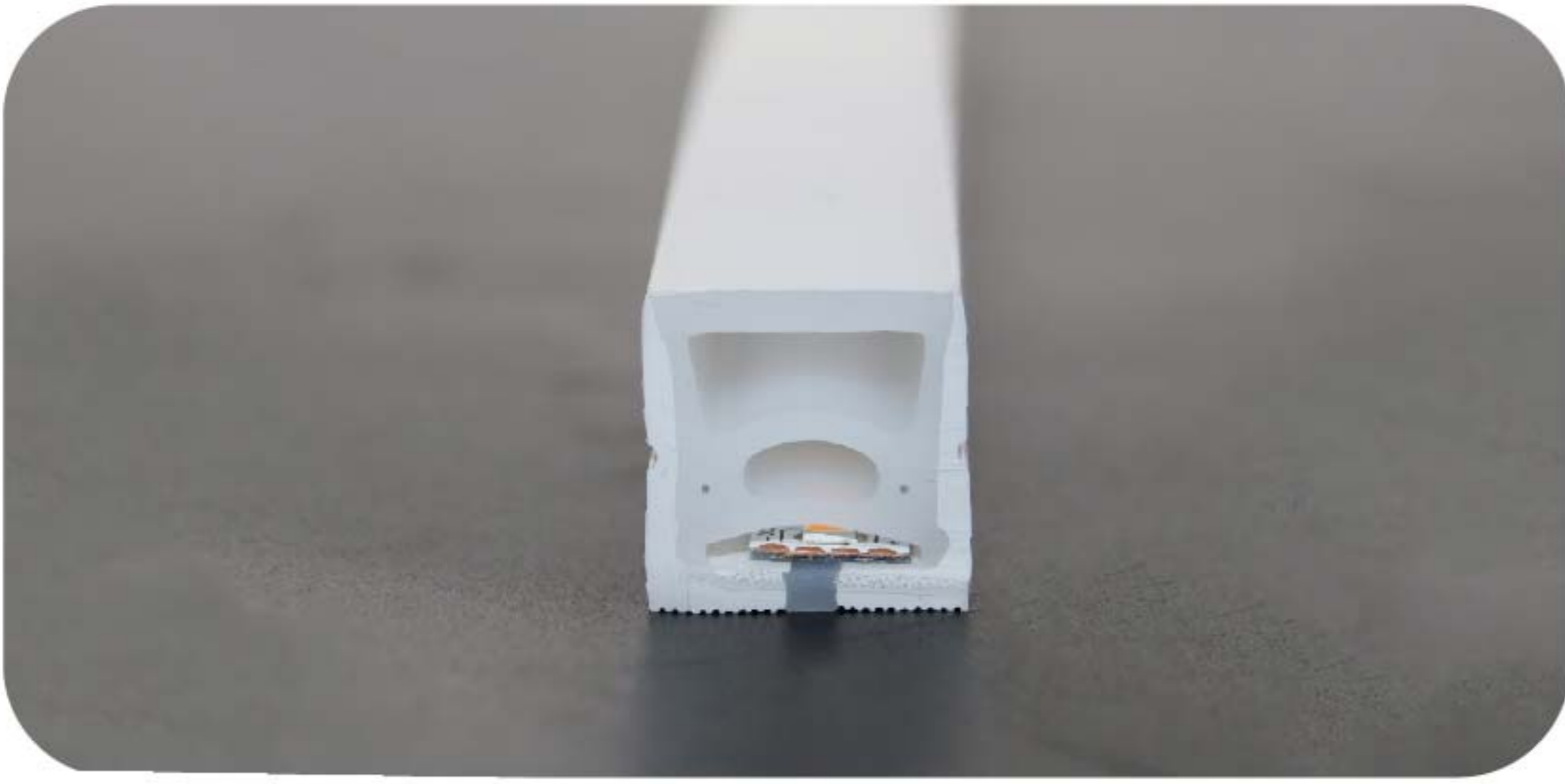

Unique Design

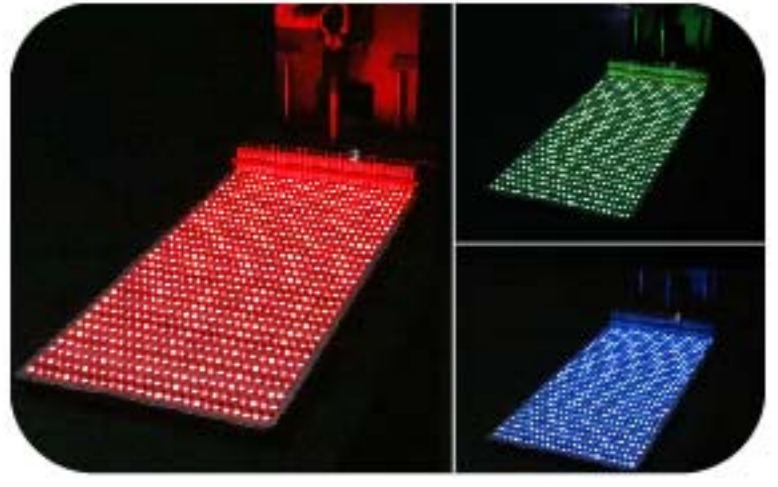

★ Enhance thickness FPC design principle

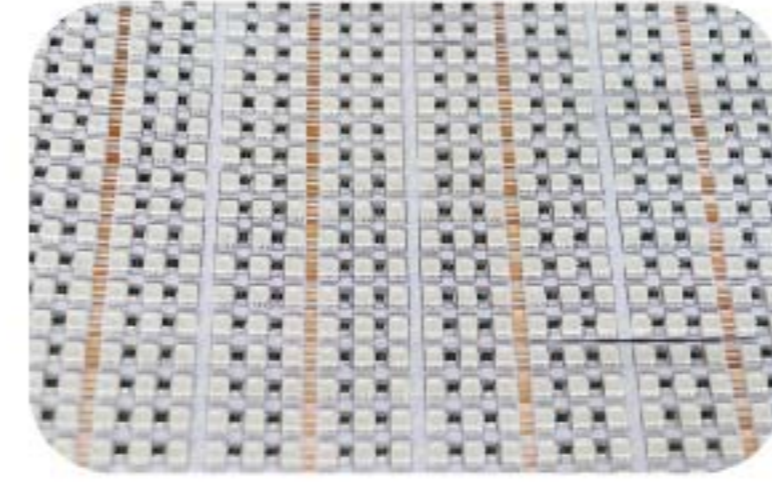

★ LED anti-death design

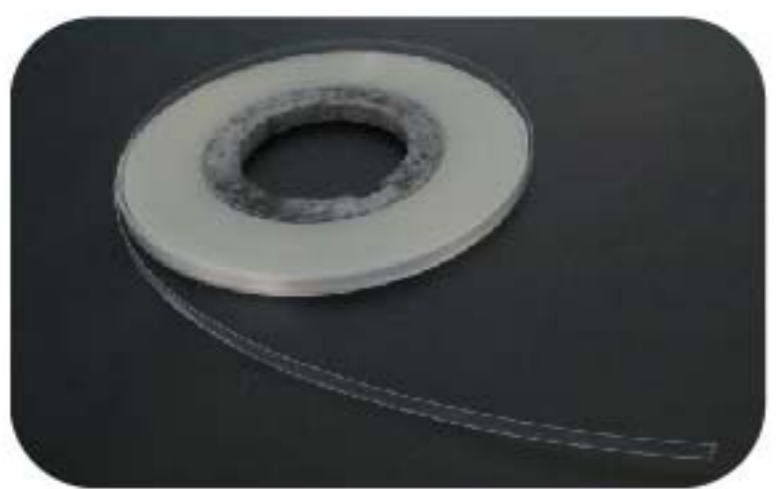

★ Add a break protection layer



★ Solid extrusion design for exterior

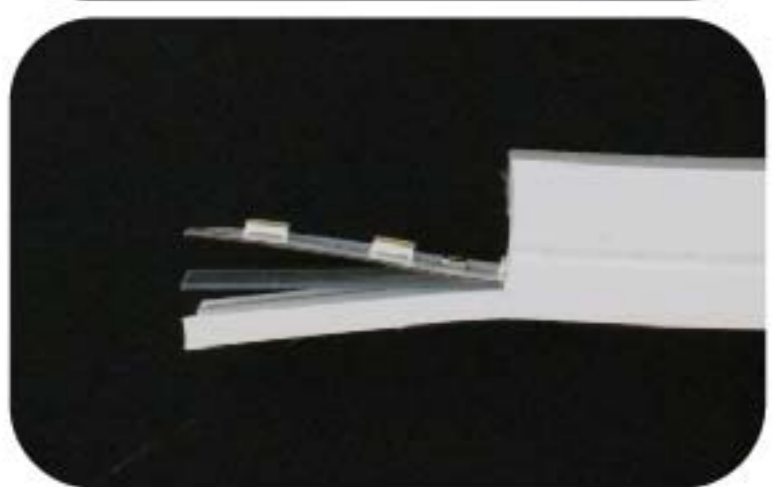

Features:

1. Size: The bigger size of this LED Neon Flex is 20x20mm (Width x Height).
2. RGB flexible neon lights are a type of LED lighting that can display a wide range of colors by utilizing red, green, and blue (RGB) LEDs. With the ability to display millions of colors, these lights can create dynamic and eye-catching effects.
3. The flexibility of these neon lights allows them to be shaped and mounted in various ways, making them suitable for a variety of applications. They are often used for accent lighting, signage, and decorative purposes in both indoor and outdoor settings. Additionally, their energy-efficient design means they consume less power than traditional neon lights.
4. RGB flexible neon lights typically come with a remote control or a programmable controller that allows the user to adjust the color, brightness, and effects of the lighting. Some models also come with sound sensors, which enable the lights to respond to music or ambient noise.
5. Overall, RGB flexible neon lights are a versatile and vibrant lighting solution that can add a colorful and dynamic element to any space or event.

Wide Color Options

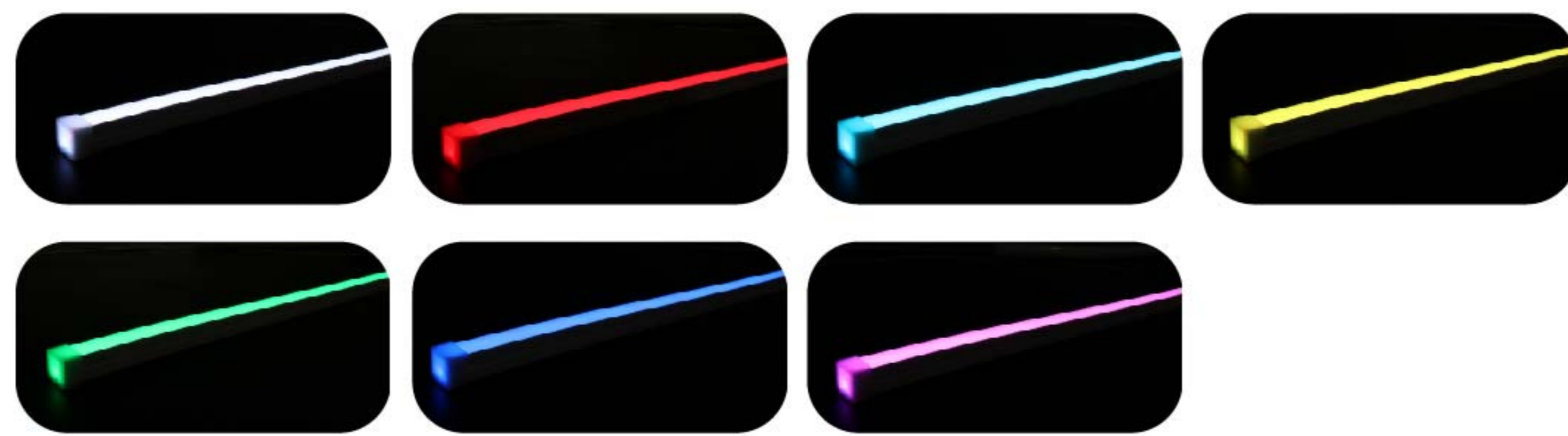

RGB Color Mixing - Color changing, Fading, Chasing effect

Recommended Usage Scenarios :

1. Indoor and outdoor architectural lighting decoration
2. Landscape lighting
3. Advertising signage lighting
4. Stage and theater lighting
5. Car and motorcycle lighting
6. Holiday and event lighting decoration
7. Cove lighting
8. Edge-lit lighting
9. Retail and display lighting
10. Restaurant and bar lighting

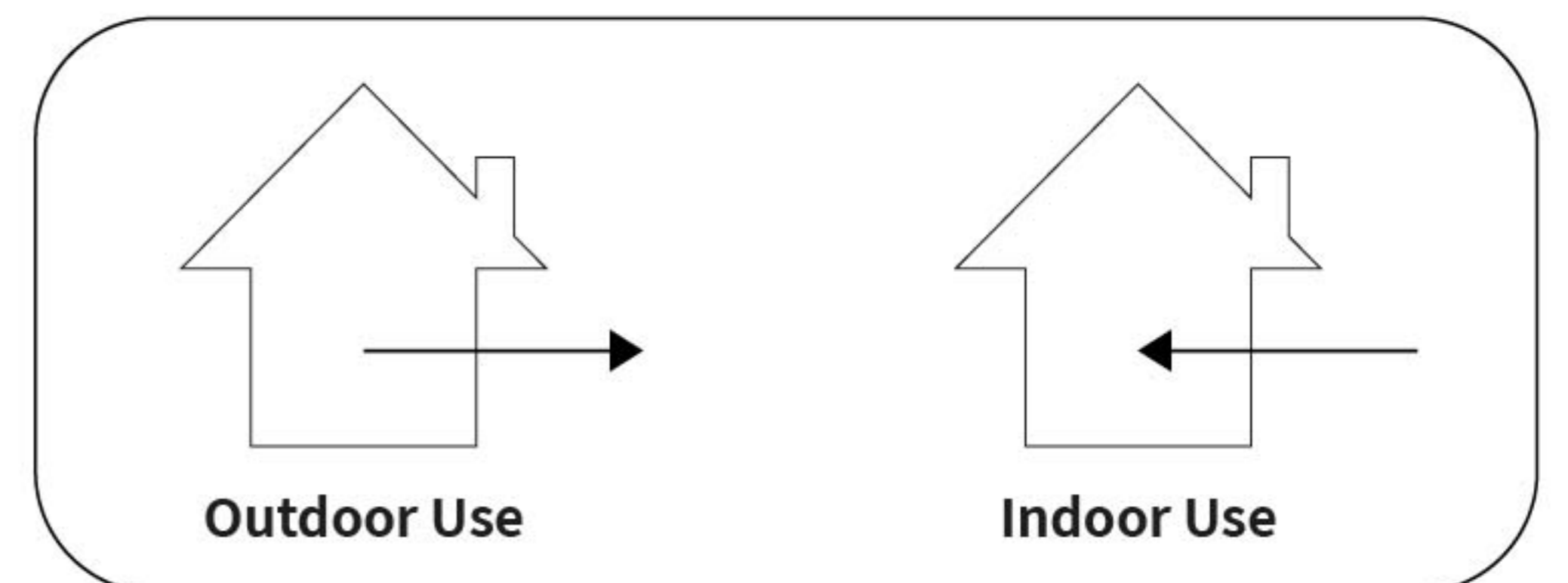

Please note that these are only recommended usage scenarios and it is important to consult the product specifications and guidelines before using flexible LED neon light strips in any application.



Package



Packing Method : Blister + White box
 Quantity / Box : 5 meters / reel
 Gross Weight : 1.5 Kg (3.31LB)
 Size of outer box : 52x 52x 7 cm
 CBM : 0.019m³ / box

Mini Cutting Length & Connection Length

• Voltage (12V/24V)

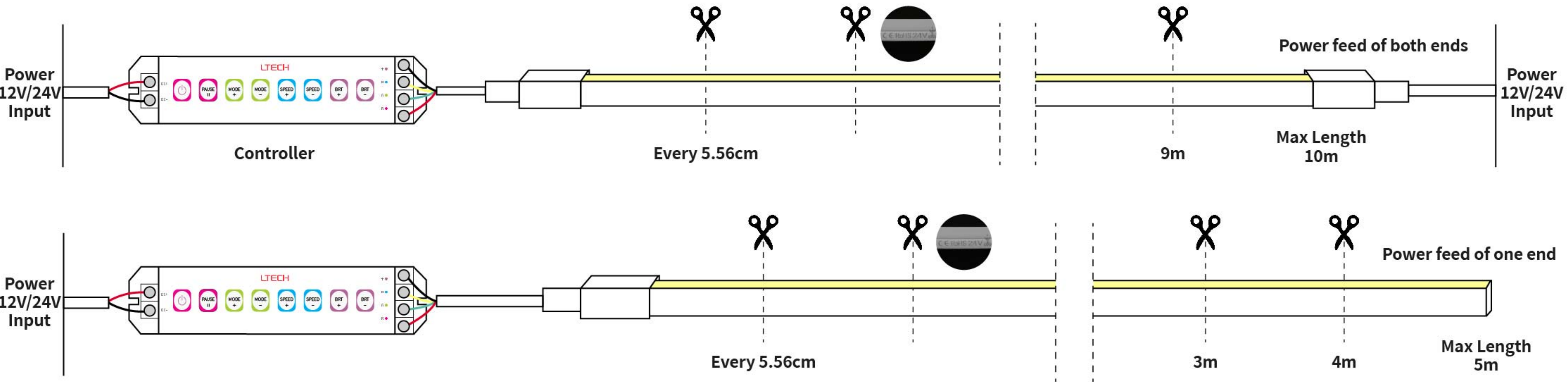

Controller (PWM compatible controller - 4 wires: 24V+, Red- , Blue- and Green-)



**LT-3600RF
LED RGB Controller**

IP65 (DIY Connector)

• Voltage (12V / 24V)

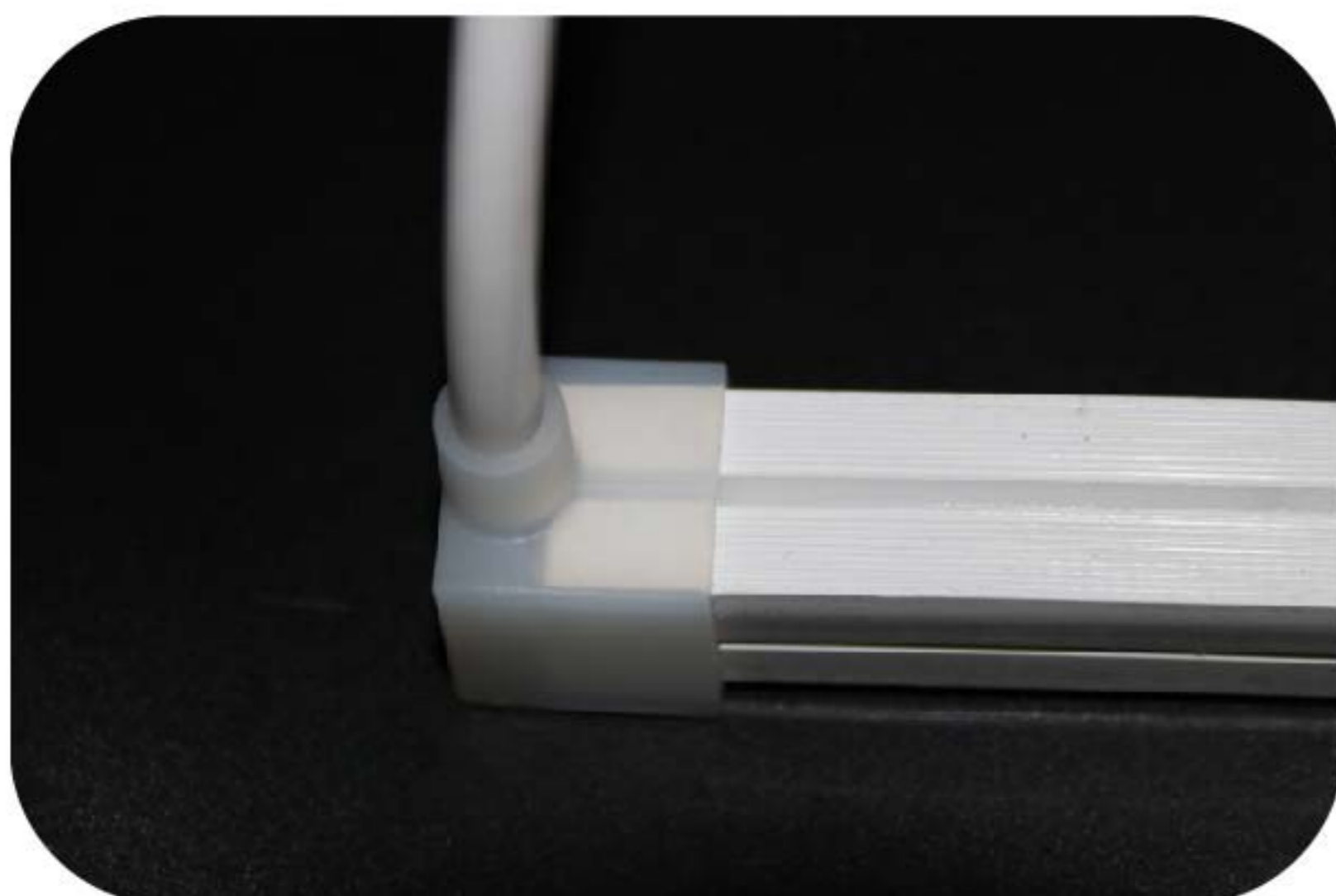

BOTTOM EXIT



SIDE EXIT



STRAIGHT EXIT

• Part Details

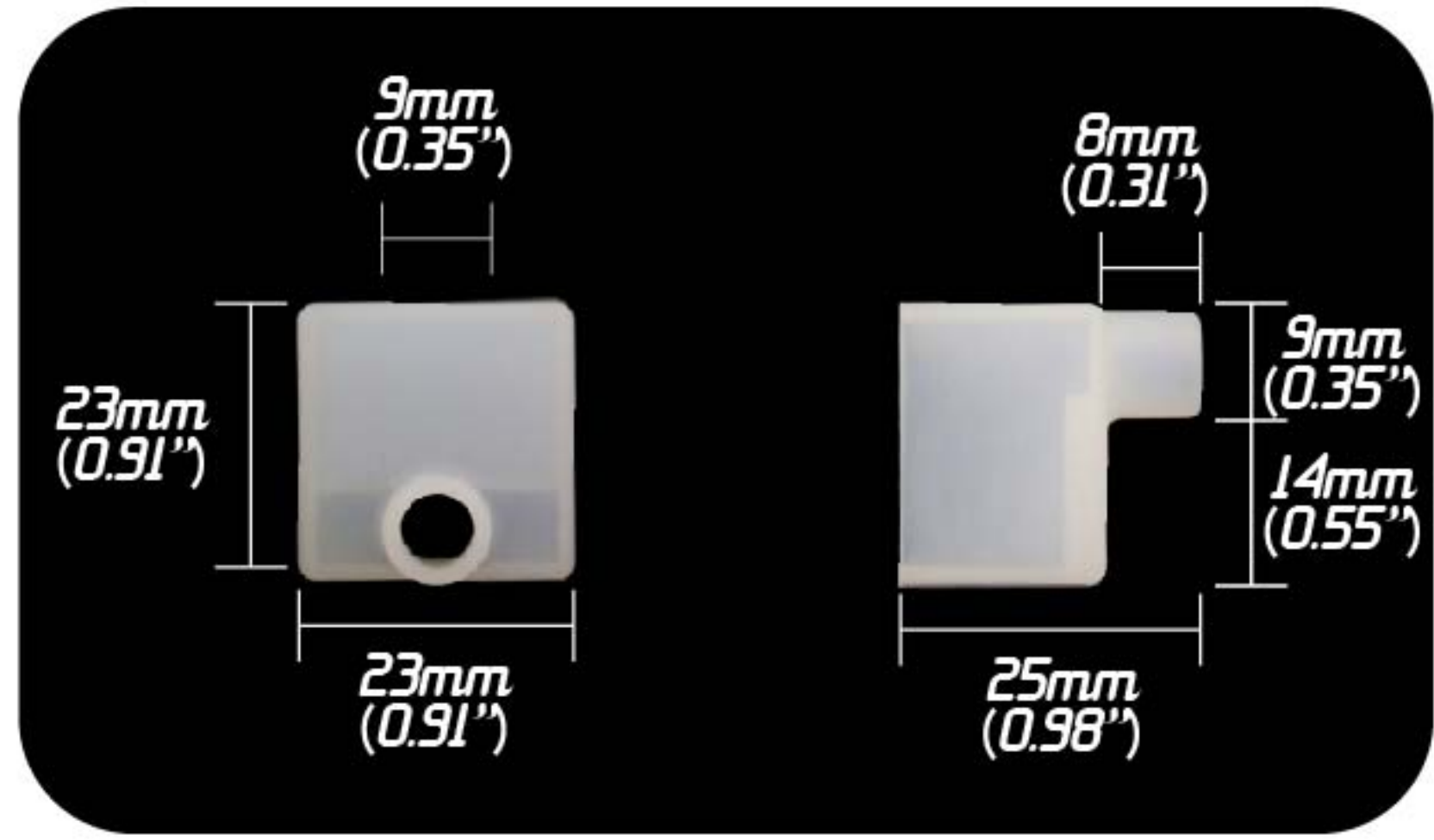

FRONT CONNECTION FITTING

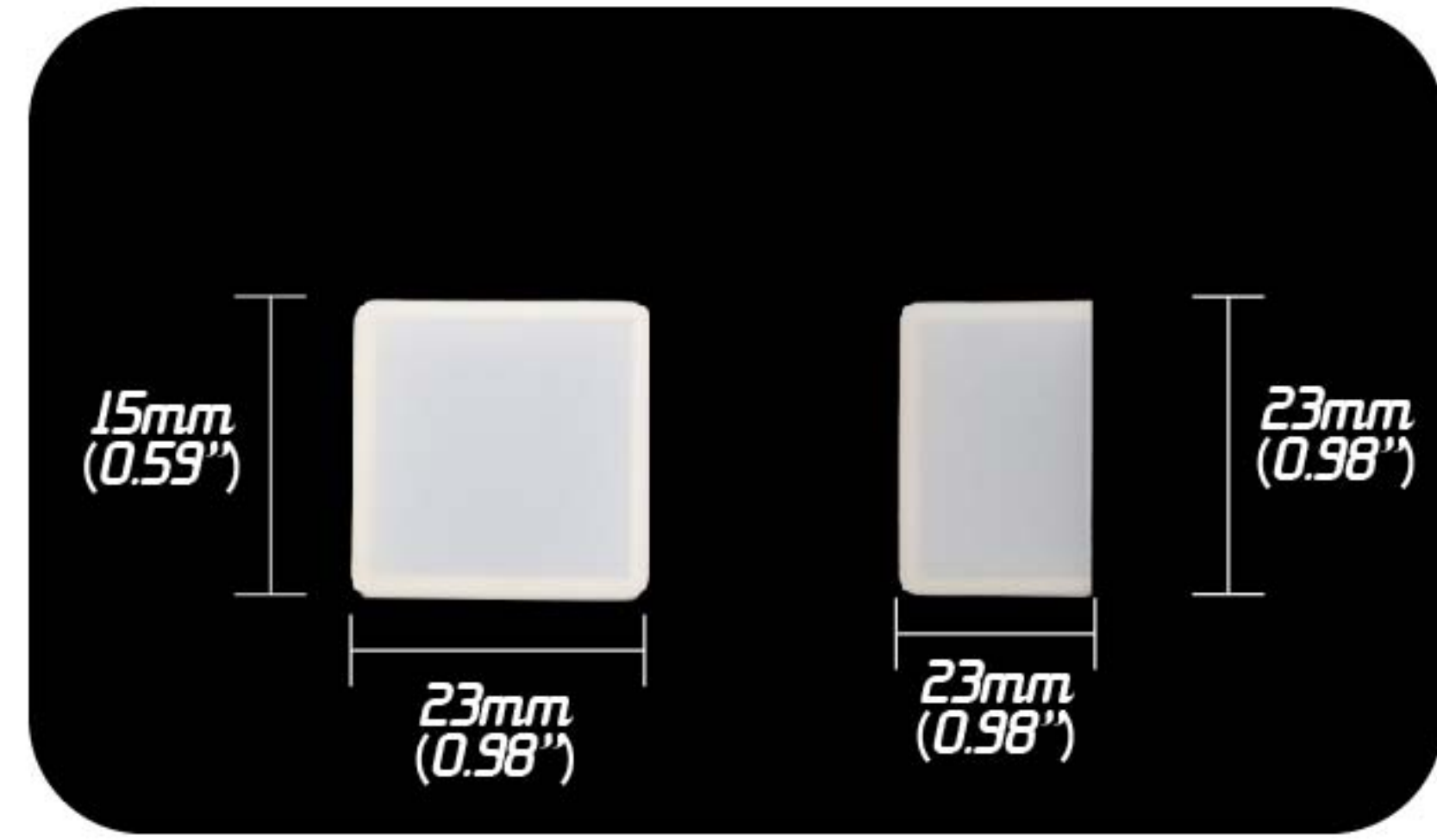

TAIL FITTING

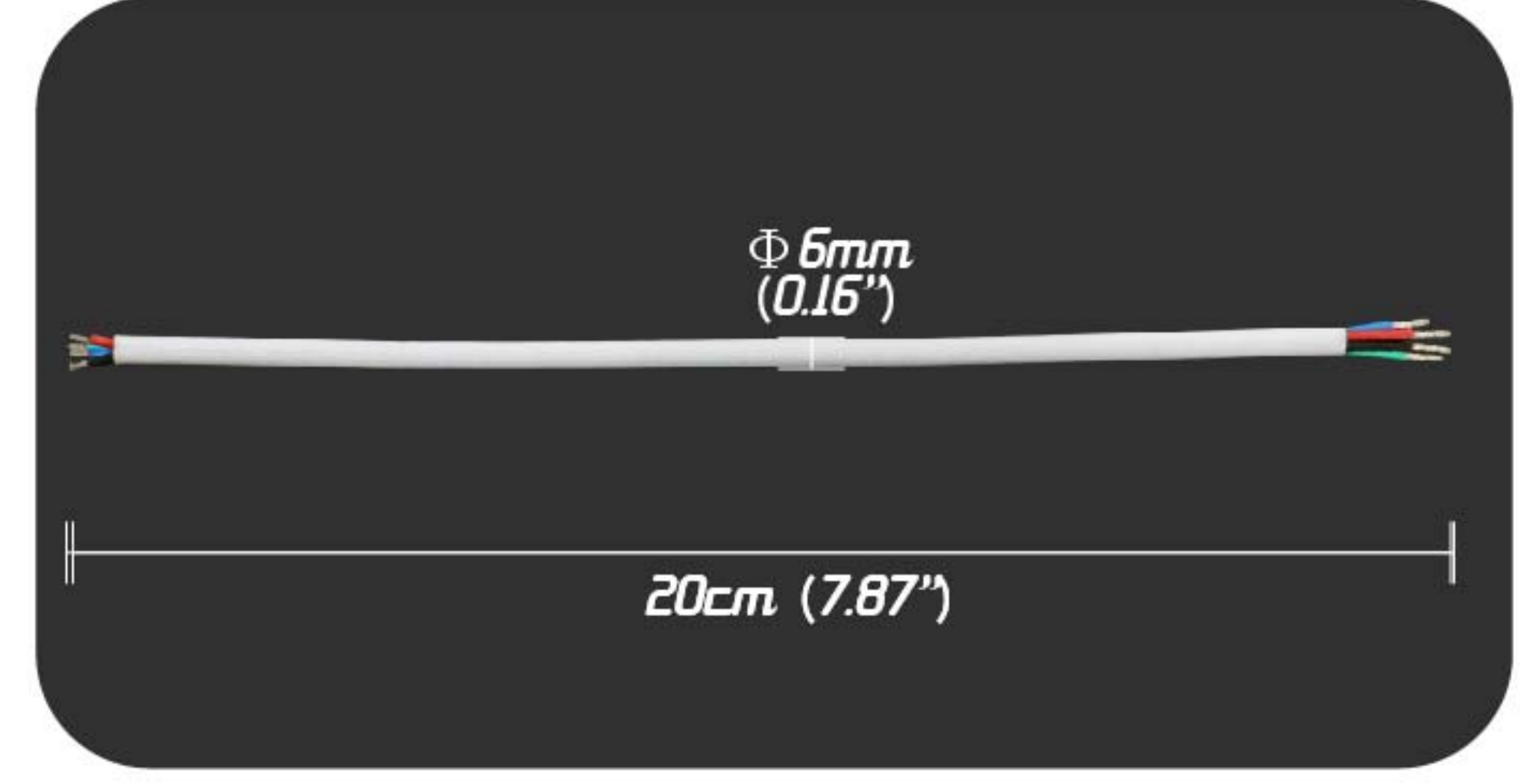

SILICONE POWER WIRE (4 CORDS)

Mounting Aluminum Channel



2CM ALUMINUM PROFILE



ALUMINUM CHANNEL (1M)

